

# VRLA

Technical Handbook



# ONE OF THE WORLD'S LARGEST BATTERY MANUFACTURERS

243,540  
EMPLOYEES\*1



54  
BILLION  
SALES\*2



Panasonic Industry Europe  
Headquarters in Ottobrunn  
(near Munich)





## Panasonic Industry Europe



Batteries



Automotive



Industry

Panasonic Industry Europe GmbH is part of the global Panasonic Group and provides industrial products and services in Europe. As a partner for the industry sector, Panasonic researches, develops, manufactures and supplies technologies that contribute to a better life and a better world. Looking back on over 100 years of engineering knowhow in electronics, Panasonic is the right supplier when it comes to engineering expertise combined with solution competence. The portfolio covers key electronic components such as batteries, devices and modules up to complete solutions and production equipment for manufacturing lines across a broad range of industries.

## Panasonic Batteries

Panasonic offers a wide range of power solutions for portable and stationary applications. Our product range includes high reliability batteries such as Lithium-Ion, Lithium-Ion Pin-type, Lithium, Nickel-Metal Hydride, Nickel-Cadmium, Valve-Regulated-Lead-Acid (VRLA), Alkaline, and Zinc-Carbon. With this breadth and depth to the portfolio, we can power your business in virtually all applications.

Panasonic began manufacturing batteries in 1931 and is today the most diversified global battery producer worldwide, with an extensive network of manufacturing companies. The company employees are dedicated to research, development and production of batteries for an energised world.

Our battery production facilities use leading-edge manufacturing processes that meet the toughest quality standards. All our factories are certified to ISO standards – with ISO 9000 and ISO 14000 being the minimum benchmarks. This means each factory has its own quality and environmental management, delivers products that measure up to toughest standards of reliability.

## Certifications

'Quality is our Business' – this is what Panasonic stands for. It is the principle for all our batteries and supporting services. This commitment is confirmed by numerous certifications.



Panasonic Industry Europe Office in Hamburg

\*1 Employees of Panasonic Corporation

\*2 Refers to the fiscal year ended March 2019

of Panasonic Corporation, based on exchange rate EUR/JPY 128.

# YOUR TOOLS TO FIND

At Panasonic Batteries we offer diverse services intended to make the customer's life easier. Find the right pictures and media files in our Mediapool, gain insight into battery technology in our handbooks and white papers and be entertained by watching amazing videos at our YouTube Channel. Finally, our Battery Finder will help you to find the right battery for your application. Test our services!

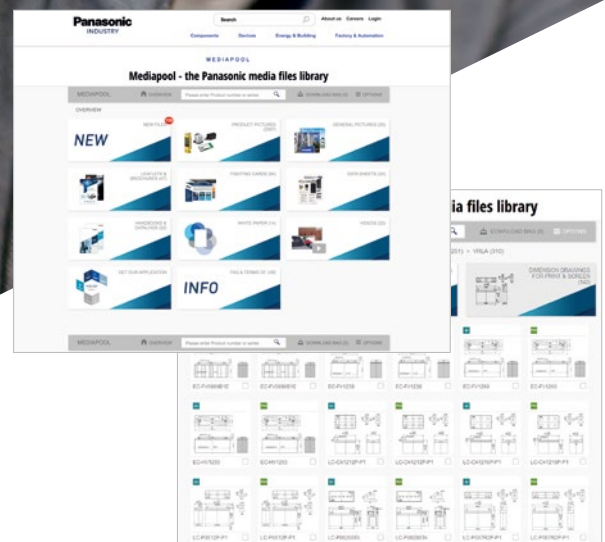
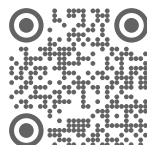
## Mediapool

Download the right battery media files

The Panasonic Industry Mediapool is a complete online library of Panasonic battery images, videos, handbooks, press releases, and white papers, providing you with just the right material for all sorts of projects. The Mediapool is open to all visitors to the Panasonic website, and offers material for both print and web. The image files differ with respect to their resolution (image size) and colour space (CMYK or RGB). The library contains files in six formats: TIF, PNG, JPG, AI, PDF, and MP4. New files appear in the folder 'New files' for three months.

You can assemble as many files as you need and download them directly to your computer. Here's an overview of what you can do:

- Locate the material you need by product name or by clicking through the categories
- Preview file details – the preview function tells you the full name of the file, its size, format, and resolution
- Select the files you wish to download. You can take files from multiple folders, or select all the material in a particular folder or category in one-click operation – there's no need to select each one individually
- Preview your personal 'Download bag' of the files you have selected
- The Mediapool zips your data into a file, which you then download to your computer. You unzip the file to the location of your choice simply by double-clicking the file name. The material is then ready for use.

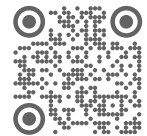




## Short Form Catalog and Handbooks

Get the right product overview

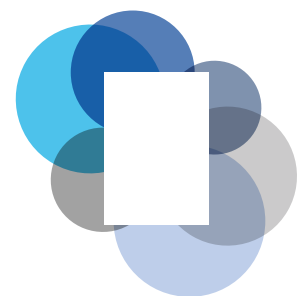
Our range of digital tools to help you in your daily work are complemented by our 'classics' on paper: the Short Form Catalog and the technical handbooks on the various battery product groups. These remain popular with customers as valuable reference aids.



## YouTube Channel

Find the right battery video

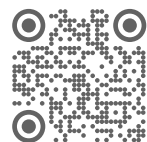
Please find a comprehensive selection of Panasonic battery videos at our YouTube channel. You can discover videos about the inner structure of our different battery chemistries, a couple of application videos and films which explain why batteries sometimes help to save human lives and sharks' lives as well. Are you getting curious? Please follow the QR code to our batteries video world!



## White Paper

Find the right technical information

Our white papers give developers and technical professionals the opportunity to leverage the expertise of our specialists for their own projects. We have been manufacturing batteries for a number of decades, and over this time have accumulated considerable knowledge and experience that we wish to share.



## INDEX

---

CHAPTER	PAGE
COMPANY	2 - 3
MARKETING SERVICE TOOLS	4 - 5
INDEX	6
PRECAUTIONS FOR HANDLING VRLA BATTERIES	7 - 11
VRLA BATTERIES	12 - 14
CHARACTERISTICS	15 - 17
CHARGING METHODS	18 - 20
SAFETY / SAFETY DESIGN	21
TERMINAL DATA	22
STANDARDS	24 - 25
BATTERY LABEL DESIGN	25
BATTERY SELECTION	26
BATTERY INDEX	27
INDIVIDUAL DATA SHEETS	28 - 47
GLOSSARY OF MAIN BATTERY TERMS	48 - 50
CONTACT	52

This document should be read in its entirety and its contents fully understood before handling or using Panasonic rechargeable sealed lead acid batteries. If there are any questions, please contact Panasonic. Please keep this document available for reference. Due to the potential energy stored in the batteries, improper handling or use of the batteries without understanding this document may result in injury caused by electrolyte leakage, heat generation, or explosion.

### DEGREE OF DANGER

#### **Danger**

When the batteries are handled or used improperly, death or severe injury may occur.

#### **Warning**

When the batteries are handled or used improperly, death or severe injury may occur, and slight injury or loss of products often occur.

#### **Caution**

When the batteries are handled or used improperly, slight injury may occur and damage to the batteries and equipment may occur.

#### **Request**

When the batteries are handled or used improperly, damage to quality or performance may occur.

#### **Note 1**

Improper handling and use of the batteries may cause dangerous conditions to arise. All precautions should be taken to prevent any harmful effects from the use of the batteries.

#### **Note 2**

'Severe injury' as a result of improper handling or use of the batteries may include but are not limited to loss of eyesight, injury/burn/electric shock/fracture of a bone/poisoning with after effect, or injury that requires long-term medical treatment. 'Slight injury' covers such conditions as burns or electric shock that do not require long-term medical treatment. Damage to products is defined as extensive damage to a house, a house hold effects, a livestock, or pets.

#### **Note 3**

'Requests' are meant to prevent a decrease in the quality or the performance of the batteries.

### ENVIRONMENT AND CONDITION

#### **Danger**

1. Do not put the batteries into airtight containers or bags. The batteries tend to generate inflammable gas upon excess charge which may cause an explosion if enclosed in an airtight container.

#### **Warning**

1. The batteries must be charged using the specified charger or by maintaining the charging conditions indicated by Panasonic. If the batteries are charged under conditions other than those specified by Panasonic, they may leak, generate excessive heat, or explode.
2. When using the batteries in medical equipment, incorporate a back-up system other than the main battery in the event of power failure.
3. Insert insulation that is resistant to heat and sulfuric acid between the batteries and any metallic housing. Failure to do so may cause the batteries to smoke or burn in case of electrolyte leakage.
4. Do not place the batteries near a device that may generate sparks (such as a switch or fuse) and do not place the batteries close to fire. The batteries may generate an inflammable gas when charged excessively that may ignite upon contact with a spark or they may burn or explode due to sparks or fire.

#### **Caution**

1. Use or store the batteries in the temperature range: Discharge (operating in application): -15°C ~ 50°C. Charge: 0°C to 40°C. Storage: -15°C to 40°C. Temperatures above or below those recommended could result in damage or deformity of the batteries.
2. Avoid placing batteries near a heat-generating device (such as a transformer) which may cause the batteries to generate excessive heat, leak or explode.
3. Do not allow the batteries to be exposed to rain or sea water. If the battery terminals should get wet, they may corrode.
4. Do not use or store the batteries in a car under the blazing sun, in direct sunlight. To do so may cause the batteries to leak, generate excessive heat, or explode.
5. Do not use or store the batteries in a dusty place as dust may cause them to short circuit between their terminals. When using the batteries in a dusty place, check them periodically.
6. In applications requiring more than one battery, first connect the batteries together and then connect the batteries to the charger or the load. Be careful to connect the (+)pole of the batteries to the (+)terminal of either the charger or the load. Improperly connecting

## PRECAUTIONS FOR HANDLING VRLA BATTERIES

the batteries, charger, or load may cause an explosion or fire to occur. In some cases, bodily injury may occur.

7. When handling the batteries, wear steel-tipped shoes to prevent possible injury to the feet if the batteries are accidentally dropped.

### Request

1. Dropping a battery may cause a strong physical shock that may damage the performance of the battery.
2. Confirm the life of the batteries using the real load and charger. Differences in the charging and the discharging conditions may cause a big difference in the life of the batteries.

### INSTALLATION

#### Danger

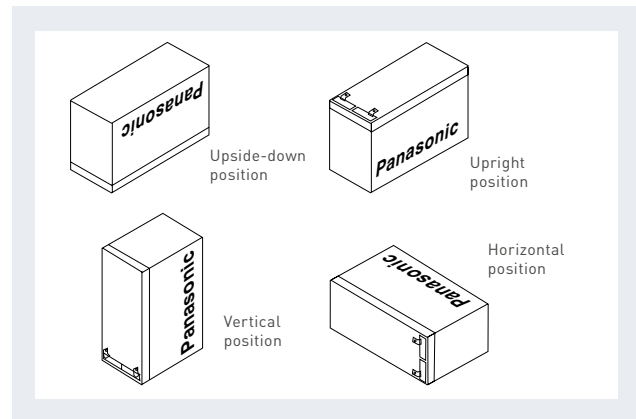
1. Tools such as wrenches used to install the batteries should be insulated. Bare metal tools may cause an abnormal short circuit accident to occur resulting in bodily injury, damage to the batteries, explosion or fire.
2. Do not install the batteries in a room without ventilation. The batteries tend to generate an inflammable gas upon excess charge resulting in an explosion or fire if the room is closed.

#### Warning

1. Do not contact any plastic or resin\*<sup>1</sup> which contains a migrating plasticizer with the batteries. Furthermore, avoid using organic solvents such as thinner, gasoline, lamp oil, benzene and liquid detergent to clean the batteries. The use of any of above materials may cause the containers and/or the covers (ABS resin) of the batteries to crack and leak. This may cause a fire in the worst scenario. Make sure the use of material will not cause the containers and/or the covers of the batteries to crack due to the migration of plasticizer within the material by asking the manufacturer of the material if necessary.
2. Always use such as rubber gloves when handling batteries with the voltages higher than 45V in order to prevent severe bodily injury from occurring.
3. Do not install the batteries in areas where they may come in contact with water. If the batteries come in contact with water, an electric shock may occur.

#### Caution

1. During unpacking, handle the batteries carefully and check for cracks, breakage, or electrolyte leakage. Failure to handle carefully may result in damage due to physical shock.



2. When the batteries are being mounted in the equipment, consider the best position for easy checking, maintenance and replacement. In addition, the batteries should be located in the lowest part of the equipment as possible. The rechargeable sealed lead acid batteries, mentioned in this document, are designed for use in any position, **but charging the batteries in the upside-down position should be avoided**. When these batteries are charged excessively in the upside-down position, leakage of electrolyte from the rubber vents may occur. The upside-down is shown on the previous page. In this upside-down position, the mark 'Panasonic' on the battery is turned upside down. The drawings are only for explanation of the battery's position; therefore these are not equal to the real appearance of the battery that the specifications describe. Can be used in the vertical position and the sidedown position (maximum angle of 90°C from the normal position).
3. Do not carry the batteries by picking up them by their terminals or lead wires. To do so may damage the batteries.
4. Be careful not to jolt the batteries as it may result in damage to them.
5. Be aware the batteries are relatively heavy compared to their volume. Please be careful to carry these batteries in order to avoid injury and/or lumbago.
6. Do not cover the batteries with plastic sheet as it may cause a fire or an explosion by conducting static electricity.
7. Fasten the bolts and the nuts with the torque as shown on page 11: Not to do so may cause the battery terminals to break.

\*<sup>1</sup> Examples for plastic or resin which should be avoided using: vinyl chloride, oily rubber.

Examples for plastic or resin which is proper for the use: Polyolefin resin such as polypropylene, polyethylene.



Bolt (nut) size (mm)			Fastening torque (Nm)
Diameter	Pitch	Length	
M5 (5)	0.8	15 ± 1	2.0 - 3.1
M6 (6)	1.0	20 ± 1	4.1 - 5.6
M8 (8)	1.25	20 ± 1	8.2 - 10.2

- Place the necessary insulating covers over the terminals, the connecting bars, and bolts and nuts to prevent a dangerous electric shock.
- Please consult Panasonic prior to using the batteries in applications such as a motor bicycle, an engine driven lawn mower, etc. which may generate severe vibration.
- Fasten the batteries firmly to the equipment to avoid the influence of vibration and/or physical shock.

**Request**

- The batteries should be installed by a certified technician.

**PREPARATION PRIOR TO OPERATION**

**Danger**

- Be sure to provide enough insulation around the lead wires and/or plates used between the batteries and the application. Insufficient insulation may cause an electric shock. Heat generating from a short circuit (or excess current) may result in an injury, burn, smoke or fire.

**Caution**

- Do not plug the batteries directly into the outlet or the cigarette receptacle of a car without inserting a charger between the batteries and the outlet or the receptacle. To do so may cause electrolyte leakage, heat generation, or explosion of the battery.
- Turn off the circuit switch when the connections between the batteries and the charger/load are made.
- When using the batteries for the first time, check for rust, heat generation, or any other abnormalities. If found, do not use as it may cause electrolyte leakage, heat generation, or explosion.

**Request**

- Since the batteries tend to lose a part of their capacity due to self-discharge during shipment and storage, recharge the batteries before you use them after purchase or long-term storage in order to restore their full capacity. Check for the following conditions before recharge:

Charging method	Charging condition (at 20°C)
<b>Constant voltage</b>	<ul style="list-style-type: none"> <li><input type="radio"/> Regulation range of the controlled voltage: 7.25V to 7.45V/6V battery, 14.5V to 14.9V/12V battery; initial current: 0.1CA to 0.4CA; maximum charging time: 24 hours.</li> <li><input type="radio"/> Short-time charge is possible when several batteries of the same model, under the same storage conditions can be charged in series. Otherwise they can be charged separately.</li> </ul>
<b>Constant current</b>	<ul style="list-style-type: none"> <li><input type="radio"/> Charging current: 0.1CA</li> <li><input type="radio"/> Charging time (hours) = [Amount of self-discharge (Ah)/0.1CA] x 120%</li> <li><input type="radio"/> Rough estimation of amount of self-discharge is as follows [for an example]: When the storage ambient temperature is lower than 20°C, and storage time is known, assume the following amount of self-discharge: [5%/month] x storage months</li> <li><input type="radio"/> Multiply this by the rated capacity (at 20 hours rate) of the battery.</li> <li><input type="radio"/> Regardless of the above calculation, the charge time for a refresh charge must be less than 12 hours.</li> <li><input type="radio"/> When the storage ambient temperature is higher than 20°C, please consult Panasonic.</li> </ul>

**UNSPECIFIED USE**

**Caution**

- Do not place the batteries in an unspecified use or they may leak, generate heat, or explode.

**METHOD OF HANDLING AND OPERATION**

**Danger**

- Do not directly connect the positive and negative terminals with a conductive material such as a wire. Be careful while using a metal tool such as a wrench and/or carrying the batteries with metallic necklaces and hairpins not to make a short circuit. A short circuit of the battery's terminals may cause a heat generation, an explosion, or a fire.

**Warning**

- Never dispose the batteries in a fire as it may cause them to explode or generate a toxic gas.
- Do not attempt to disassemble the batteries as it could cause leakage of Sulfuric acid that could cause injury.

**Caution**

- To prevent accidents from happening, change any battery that is found to have an abnormality such as a crack, a deformity, or leakage. The batteries must be kept clean and free from dust to prevent loss of capacity or accident.
- If any abnormality of the charge voltage or the discharge

## PRECAUTIONS FOR HANDLING VRLA BATTERIES

---

voltage is detected, replace the batteries with new ones.

3. Charging the batteries with an inverse polarity connection between the batteries and the charger could cause electrolyte leakage, heat generation, or a fire.
4. Do not solder directly on the batteries' terminal tabs. Soldering directly on the batteries' terminals may cause a leak of electrolyte. Consult Panasonic when soldering is necessary.
5. Avoid the use of the batteries differing in capacity, type, history of use (charge/discharge operation). These differences could cause electrolyte leakage or heat generation.
6. Do not remove or scratch the outer tube of the battery or it may cause an electrolyte leakage or electrical leakage.
7. Do not allow the batteries to be subjected to any strong physical shocks or jolts while moving them. Treating the batteries roughly could cause leaks, heat generation, or explosions.
8. Do not charge the batteries beyond the amount of the time indicated in the specifications, or do not charge after the charge indication lamp indicates a full charge. Take the batteries off the charger if the charge is not finished after the specified charge time. Over-charging can cause leakage, heat generation, or explosions.
9. Children should be taught how to handle and use the batteries correctly.
10. Keep the batteries out of the reach of small children at all times.

### Request

1. The cut-off voltage during discharge should vary depending on the discharge current. Do not discharge the batteries lower than the recommended cut-off voltage shown in Panasonic specifications or Panasonic technical handbooks. Recharging a battery which was once discharged below the recommended cut-off voltage may generate heat, resulting in the deformation of the battery or in condensation around the battery cover caused when moisture within the battery evaporates. In addition, the efficiency of the battery would eventually decrease. Overdischarging a battery may result in reduced performance. Always recharge the batteries immediately after discharge even if the batteries were not discharged to the recommended cut-off voltage. If the batteries are not charged soon after discharge, the batteries performance may be reduced due to the so-called 'sulfation phenomena'.  
**Note:** The cut-off device to prevent overdischarge should cut off all discharge current including any weak current.
2. Thoroughly study the charge methods and the conditions of the batteries before adopting other charge methods which are not shown in the Panasonic speci-

cations or the Panasonic technical handbook, for safety reasons.

3. When the batteries are used in a cyclic application, it is important to charge the batteries for the proper amount of time. A timer should be incorporated into the charging circuit that will disconnect the charging current to prevent overcharging. Also, it is important to allow the battery to completely charge before removing the battery from the charger.
4. Avoid parallel charging of the batteries in cycle use. This may shorten the life of the batteries by causing an imbalance in the charge/discharge operation of the batteries.
5. Measure the total voltage of the batteries during trickle charge (or float charge), using a voltage meter. If the total voltage of the batteries provide an indication deviating from the specified voltage range, be sure to investigate the cause. If the total voltage is lower than that specified, the batteries may lose their capacity because of a lack of sufficient charge. However, if the total voltage is higher than that specified, the batteries may lose their capacity by damage due to overcharge and may suffer from 'thermal runaway' and other accidents.
6. Switch off the equipment after use to prevent loss of performance or shortened life of the batteries due to damage by overdischarge.
7. When storing the batteries, be sure to remove them from the equipment or disconnect them from the charger and the load to prevent overdischarge and loss of capacity. Before storing batteries, charge the batteries fully. Do not store batteries in a highly humid place to prevent rust from forming on the terminals.

### MAINTENANCE

#### Warning

1. When cleaning the batteries, use a soft damp cloth. A dry cloth may cause static electricity which could result in a fire or explosion.
2. Replace batteries with the new ones before the end of their useful life as determined in the specifications. When the batteries are near the end of their life (50% state of their initial discharge duration time) the remaining life will shorten remarkably. Finally the batteries will lose their available capacity by either drying out their electrolyte (causing increase in their impedance) or an internal short-circuit. In such case, if the batteries go on charging, thermal runaway and/or leakage of electrolyte may occur. The batteries should be replaced before reaching these conditions.  
The expected life of the batteries (in trickle or float use) will decrease to half (50%) with each 10°C rise in

temperature above 20°C. In particular, the life of the batteries will be shortened remarkably at approximately 40°C. Accordingly, precautions are required to prevent the use of batteries at high temperatures.

### Caution

1. Avoid using organic solvents such as thinner, gasoline, lamp oil, or benzine, and liquid detergent to clean the batteries. These substances may cause the battery containers to crack or leak.

### Request

1. Keep the battery terminals clean in order to avoid interruption in the discharge and/or to maintain the charge.

### TREATMENT AT EMERGENCY

#### Warning

1. The batteries have toxic liquid – dilute sulfuric acid solution in them. If the acid comes into contact with skin or clothes, wash skin or cloth with lots of clean water to prevent scalding from occurring. If the acid should come into contact with the eyes, wash the eyes with lots of clean water and consult a physician immediately to prevent possible loss of sight.

#### Caution

1. Check the batteries visually for any sign of irregularities in appearance. If any damage exists such as cracks, deformation, leakage of electrolyte, or corrosion, the batteries must be replaced with the new ones. Irregularities in the batteries could result in bodily injury, electrolyte leakage, excessive heat generation, or explosion, if used. Furthermore, make sure the batteries are clean and free from dirt and dust.

### STORAGE

#### Caution

1. Store the batteries in a fixed position separate from metal or other conductive materials.
2. Keep the batteries from rain water that could cause corrosion on the terminals of the batteries.
3. Keep the batteries right-side-up during transportation and do not give any abnormally strong shock and jolt to the batteries. Transporting the batteries in an abnormal position or handling them roughly could destroy the batteries or cause their characteristics to deteriorate.
4. When storing the batteries, be sure to remove them from the equipment or disconnect them from the charger and the load, then store them at room temperature or

lower temperature. Do not store the batteries at direct sunlight, higher temperature or high humidity. To do so cause the batteries short life, performance deterioration or corrosion on terminals.

### Request

1. Charge the batteries at least once every twelve months if they are stored at 20°C. Use the charge method specified in '4. Charging methods'. The interval of this charge should be reduced to 50% by each 10°C rise in temperature above 20°C. The self-discharge rate doubles for each 10°C in temperature. If they are stored for a long time in a discharged state, their capacity may not recover even after charge. If the batteries are stored for more than a year at room temperature, the life of the batteries may be shortened.
2. Store the batteries starting from the fully charged state to prevent the life of the batteries being shortened.
3. Use the batteries as quickly as possible after receiving them as they gradually deteriorate even under proper storage conditions.

### DISPOSAL AND RECYCLING

#### Caution

1. Please write the information about battery recycling on the equipment, the package, the carton, the instruction manual etc. in countries where legal or voluntary regulations on battery recycling are applicable.
2. Design the equipment such that exchange and disposal of the batteries can be undertaken easily.
3. Used batteries should be recycled. When returning used batteries, insulate their terminals using adhesive tape, etc. Even used batteries still have electrical charge and an explosion or a fire may occur, if proper insulation is not given on the terminals of the used batteries.

# OUTSTANDING QUALITY FOR DEMANDING APPLICATIONS



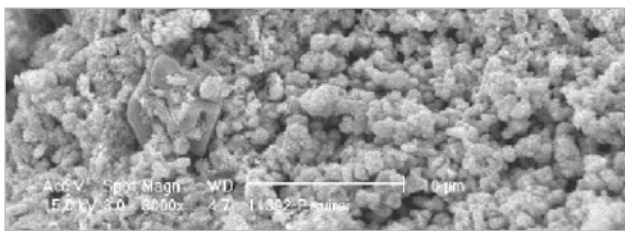
STATE-OF-THE-ART AGM TECHNOLOGY  
SUPERIOR DESIGN AND LOW VOLTAGE SPREAD  
HIGHEST QUALITY CONTROL STANDARDS  
ENHANCED LIFESPAN DUE TO EXCELLENT  
RECOMBINATION EFFICIENCY

## BATTERY CONSTRUCTION

### Positive plates

Positive plates are plate electrodes of which a grid frame of lead-calcium-tin alloy holds porous lead dioxide as the active material. The magnification of a positive active material is shown on following figure 1.

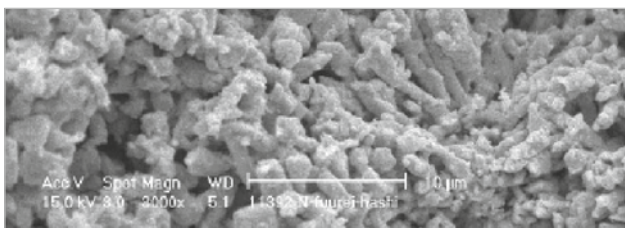
Fig. 1 Magnification of positive active material



### Negative plates

Negative plates are plate electrodes of which a grid frame of lead-calcium-tin alloy holds spongy lead as the active material. The magnification of a negative active material is shown on following figure 2.

Fig. 2 Magnification of negative active material



### Electrolyte

Diluted sulfuric acid is used as the medium for conducting ions in the electrochemical reaction in the battery. Some additives are included to keep good recovery performance after deep discharge.

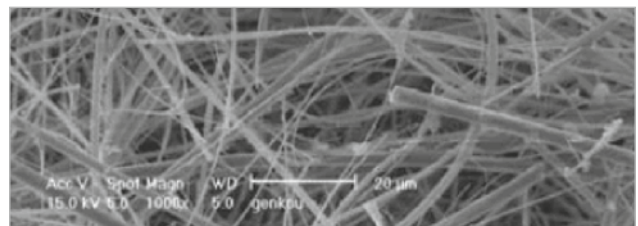
Scan QR code  
to view product  
series video.



### Separators

Separators, which retain electrolyte and prevent shorting between positive and negative plates, adopt a non-woven fabric of fine glass fibers which is chemically stable in the diluted sulfuric acid electrolyte. Being highly porous, separators retain electrolyte for the reaction of active materials in the plates. Typical magnification of separator is shown in following figure 3.

Fig. 3 Typical magnification of separator



### Vent (one way valve)

The valve is comprised of a one-way valve made of material such as Neoprene. When gas is generated in the battery under extreme overcharge condition due to erroneous charging, charger malfunctions or other abnormalities, the vent opens to release excessive pressure in the battery and maintain the gas pressure within specific range (7.1 to 43.6kPa). During ordinary use of the battery, the vent is closed to shut out outside air and prevent oxygen in the air from reacting with the active material in the negative electrodes.

BATTERY CASE MATERIALS (EXAMPLE LC-R SERIES)\*1

- 1 Negative plate terminal
- 2 Seals
- 3 Positive plate terminal
- 4 Battery case
- 5 Positive electrode
- 6 Separator
- 7 Negative electrode
- 8 Valve



Fig. 5

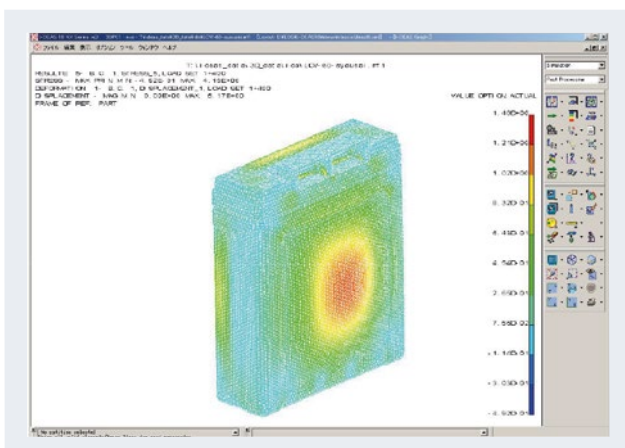
**Positive and negative electrode terminals**

Positive and negative electrode terminals may be faston tab type, bolt fastening type or threaded post type, depending on the type of the battery. Sealing of the terminal is achieved by a structure which secures long adhesive-embedded paths and by the adoption of strong epoxy adhesives. For specific dimensions and shapes of terminals see page 24.

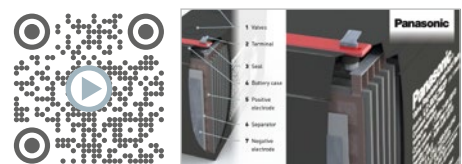
**Battery case materials and the design**

Materials of the body and cover of the battery case are ABS resins, unless otherwise specified. Since the inside of VRLA battery is pressurized and depressurized, stress occurs at the container and cover. The design according to the stress is designed to accommodate the fluctuations in stress in the event the battery becomes deformed. The thickness of container, form, material and stress analysis are determined by utilization of computer aided engineering (CAE). This depicts the container design & strength. Destructive examinations using the molded container are also carried out. In other cases in which water in electrolyte liquid may penetrate through container in service life, the container design is put through water penetration tests.

Fig. 4 CAD container design



Scan QR code to view 3D animated video.



**ELECTROCHEMICAL REACTIONS ON ELECTRODES**

The electrochemical reaction processes of the sealed lead acid battery (negative electrode recombination type) are described below. Where 'charge' is the operation of supplying the rechargeable battery with direct current from an external power source to change the active material in the negative plates chemically, and hence to store in the battery electric energy in the form of chemical energy. 'Discharge' is the operation of drawing out electric energy from the battery to operate external equipment. In the final stage of charging, an oxygen-generating reaction occurs at the positive plates. This oxygen transfers inside the battery, then is absorbed into the surface of the negative plates and consumed. These electrochemical reaction processes are expressed as follows.

**APPLICATIONS**

**Standby / Back-up power applications**

- Communication equipment: base station, PBX, CATV, WLL, ONU, etc.
- Back-up for power failure: UPS, ECR, computer system back-up, sequencers, etc.
- Energy saving: solar and/or wind powered lanterns, wind powered advertising displays, etc.
- Emergency equipment: lights, fire and burglar alarms, radios, fire shutters, stop-position controls (for machines and elevators), etc.

\*1 The illustration shows only one example of VRLA battery structure.

FEATURES

**Leak-resistant structure**

A required-minimum quantity of electrolyte is impregnated into, and retained by, the positive and negative plates and the separators; therefore electrolyte does not flow freely. Also, the terminal has a sealed structure secured by long adhesive-embedded paths and by the adoption of strong epoxy adhesives which makes the battery leak-resistant. Note: In standby/back-up uses, if the battery continues to be used beyond the point where discharge duration has decreased to 50% of the initial (i.e. life judgment criteria), cracking of the battery case may occur, resulting in leakage of the electrolyte.

**Easy maintenance**

Unlike conventional batteries in which electrolyte can flow freely, VRLA batteries do not need the specific-

gravity check of the electrolyte or the water top up maintenance, this allows the battery to function fully with the minimum of maintenance.

**No sulfuric acid mist or gases**

Unlike conventional batteries in which electrolyte can flow freely, VRLA batteries generate no Sulphuric acid mist or gases under Panasonic recommended use conditions. If used under conditions other than recommended then gas generation may occur, therefore do not design the battery housing in a closed structure.

**Exceptional deep discharge recovery**

Our VRLA batteries show exceptional rechargeability even after deep discharge, which is often caused by failure to turn off the equipment switch, followed by standing (approx. 1 month at room temperature is assumed).

Fig. 6 Charge / discharge chemical equation

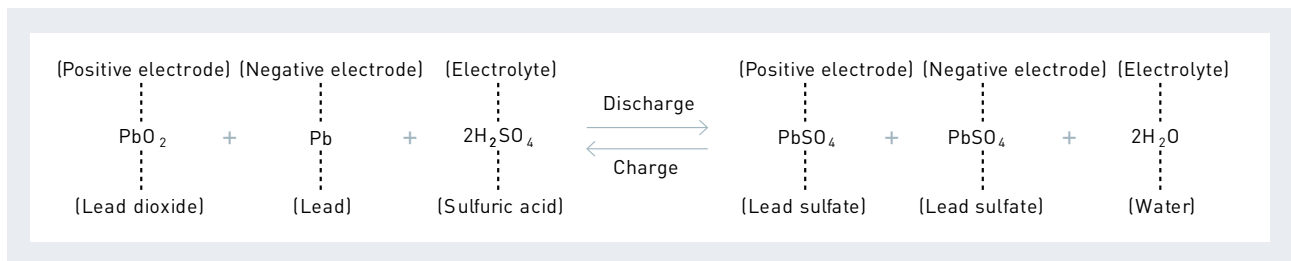
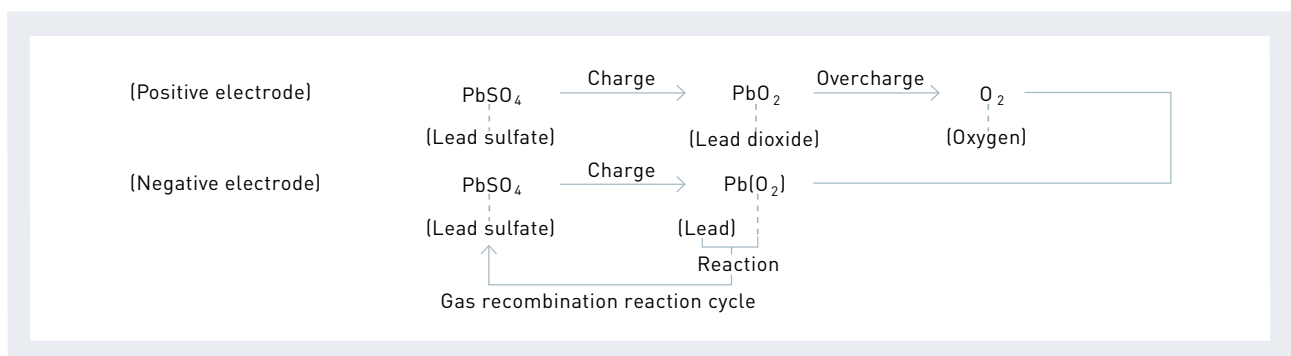


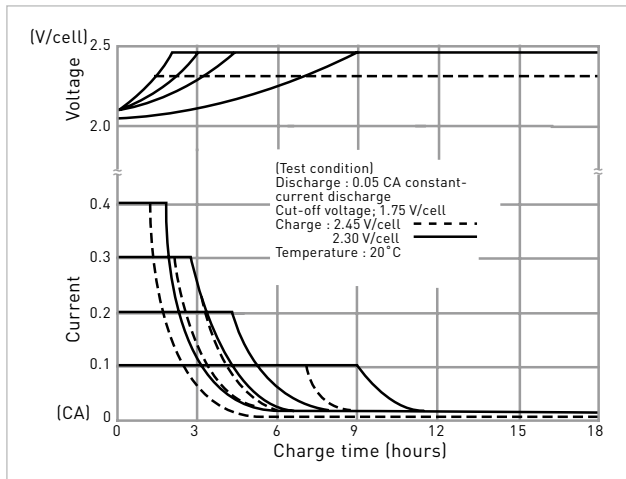
Fig. 7 Recombination chemical equation



**CHARGING**

Charge characteristics (constant voltage-constant current charging) of VRLA batteries are exemplified in the figure 1. In order to fully utilize the characteristics of VRLA batteries, constant-voltage charging is recommended. For details of charging see pages 20 – 23.

**Fig. 1** Constant-voltage charge characteristics by current (example)

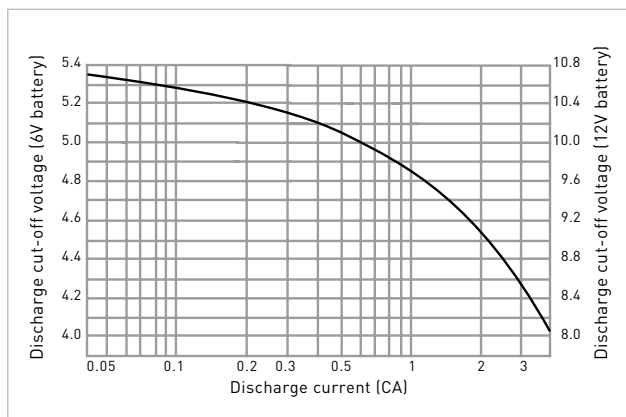


**DISCHARGING**

**Discharge current and discharge cut-off voltage**

Recommended cut-off voltages for 6V and 12V batteries consistent with discharge rates are given in the figure 2. With smaller discharge currents, the active materials in the battery work effectively, therefore discharge cut-off voltages are set to the higher side for controlling overdischarge. For larger discharge currents, on the contrary, cut-off voltages are set to the lower side. **Note:** Discharge cut-off voltages given are recommended values.

**Fig. 2** Discharge current vs. cut-off voltage



**Discharge temperature**

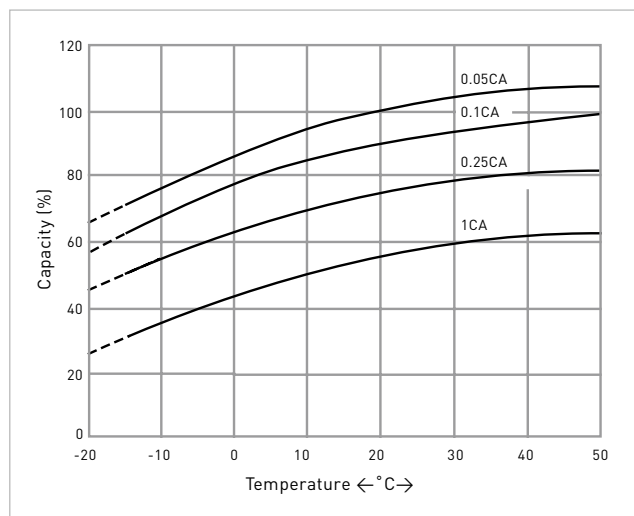
Control the ambient temperature during discharge within the range from -15°C to 50°C for the reason described below.

Batteries operate on electrochemical reaction which converts chemical energy to electric energy. The electrochemical reaction is reduced as the temperature lowers, thus, available discharge capacity is greatly reduced at temperatures as low as -15°C. For the high temperature side, on the other hand, the discharge temperature should not exceed 50°C in order to prevent deformation of resin materials which house the battery or deterioration of service life.

**Effect of temperature on discharge characteristics**

Available discharge capacity of the battery varies with ambient temperature and discharge current as shown in the figure 3.

**Fig. 3** Discharge capacity by temperature and by discharge current



**Discharge current**

Discharge capability of batteries is expressed by the 20 hours rate (rated capacity). Select the battery for specific equipment so that the discharge current during use of the equipment falls within the range between 1/20 of the 20 hours rate value and 3 times that (1/20CA to 3CA): discharging beyond this range may result in a marked decrease of discharge capacity or reduction in the number of times of repeatable discharge. When discharging the battery beyond said range, please consult Panasonic in advance.

**Depth of discharge**

Depth of discharge is the state of discharge expressed by the ratio of amount of capacity discharged to the rated capacity.

STORAGE

**Storage condition**

Observe the following condition when the battery needs to be stored.

1. Ambient temperature: -15°C to 40°C (preferably below 30°C)
2. Relative humidity: 25 to 85%
3. Storage place free from vibration, dust, direct sunlight, and moisture.

**Self-discharge and refresh charge**

During storage, batteries gradually lose their capacity due to self-discharge, therefore the capacity after storage is lower than the initial capacity. For the recovery of capacity, repeat charge/discharge several times for the battery in cycle use; for the battery in trickle use, continue charging the battery as loaded in the equipment for 48 to 72 hours.

**Refresh charge (auxiliary charge)**

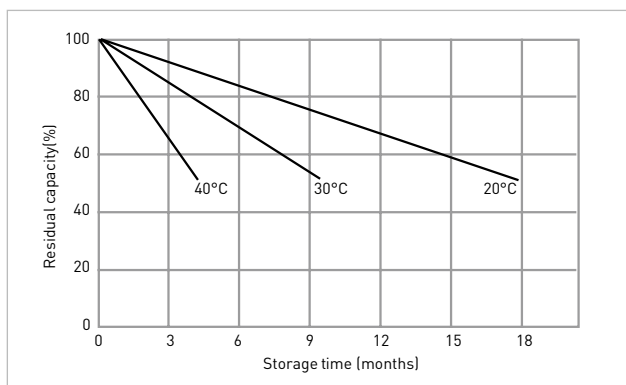
When it is unavoidable to store the battery for 3 months or longer, periodically recharge the battery at the intervals recommended in the table below depending on ambient temperature. Avoid storing the battery for more than 12 months.

Storage temperature	Interval of auxiliary charge (refresh charge)
Below 20°C	12 months
20°C to 30°C	9 months
20°C to 40°C	6 months

**Residual capacity after storage**

The result of testing the residual capacity of the battery which, after fully charged, has been left standing in the open-circuit state for a specific period at a specific ambient temperature is shown in the figure below. The self-discharge rate is very much dependent on the ambient temperature of storage. The higher the ambient temperature, the less the residual capacity after storage for a specific period. Self-discharge rate almost doubles by each 10°C rise of storage temperature figure 4.

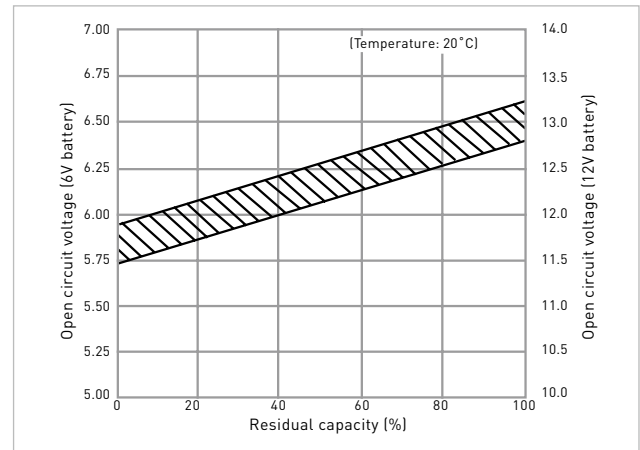
**Fig. 4** Residual capacity test result



**Open circuit voltage vs. residual capacity**

Residual capacity of the battery can be roughly estimated by measuring the open circuit voltage as shown in the figure 5.

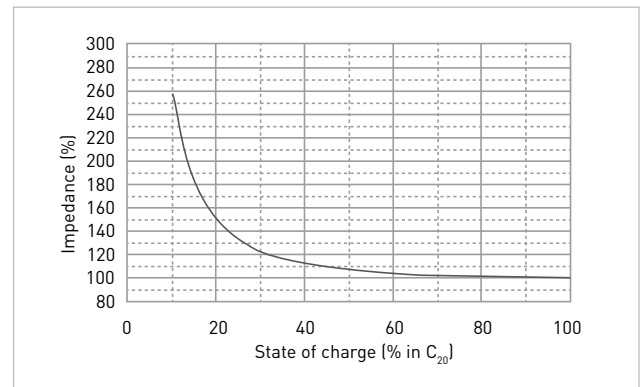
**Fig. 5** Open circuit voltage vs. residual capacity 20°C



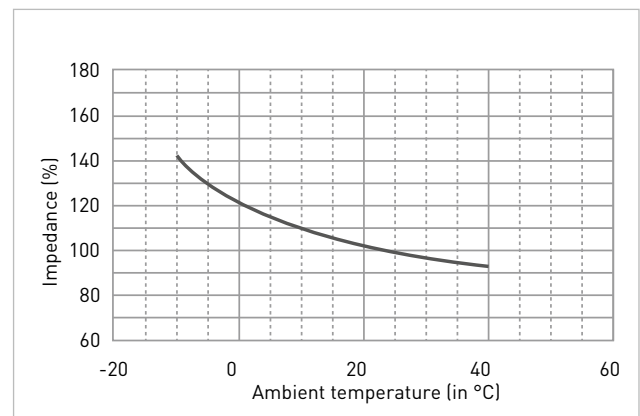
IMPEDANCE

The impedance is an important parameter of batteries. Impedance varies with the state of charge of the battery and temperature as shown on the chart below.

**Fig. 6** Relationship between impedance and state of charge



**Fig. 7** Relationship between impedance and temperature





TEMPERATURE CONDITIONS

Recommended temperature ranges for charging, discharging and storing the battery are tabulated below.

Charge	0°C ~ 40°C
Discharge	-15°C ~ 50°C
Discharge	-15°C ~ 40°C

BATTERY LIFE

Trickle (float) life

Trickle life of the battery is largely dependent on the temperature condition of the equipment in which the battery is used, and also related to the type of the battery, charge voltage and discharge current. The respective figures show the influence of temperature on trickle life of the battery, an example of trickle (float) life characteristics of the battery, and the test result of the battery life in an emergency lamp.

Fig. 8 Trickle life characteristics at 50°C

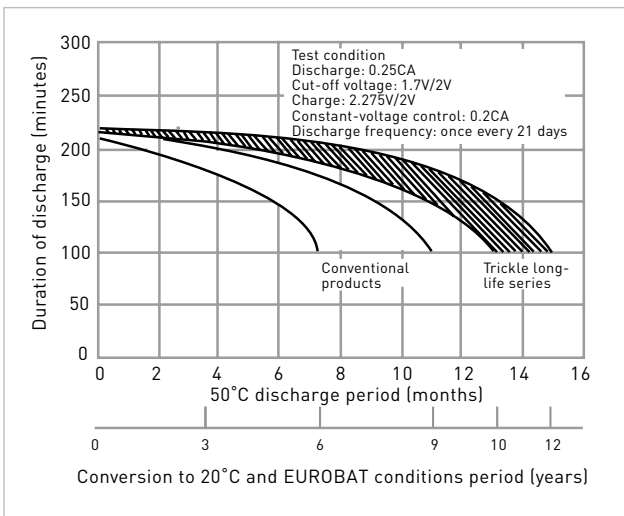
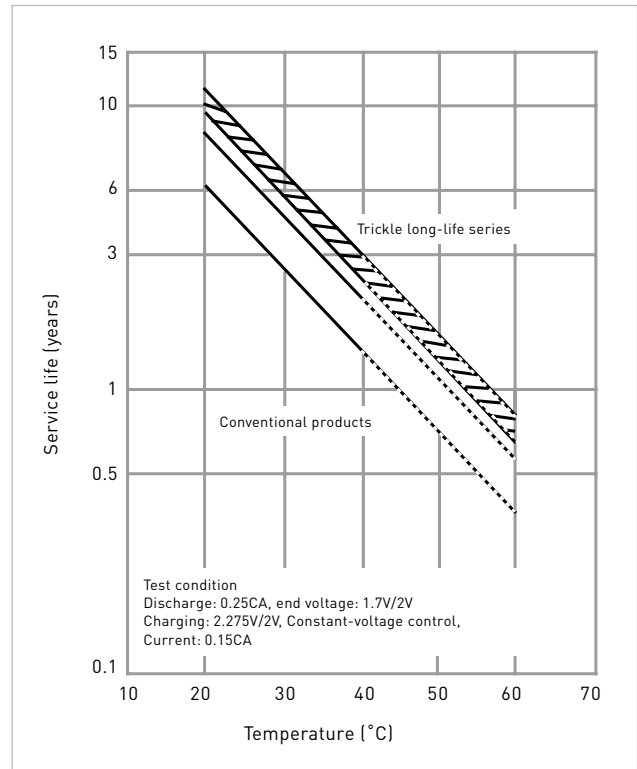


Fig. 9 Influence of temperature on trickle life



**Methods of charging the Valve-Regulated-Lead-Acid battery**

For charging the Valve-Regulated-Lead-Acid battery, a wellmatched charger should be used because the capacity and life of the battery is influenced by ambient temperature, charge voltage and other parameters.

Standby power source (trickle use)

- a Trickle charging (compensating charging)
- b Float charging

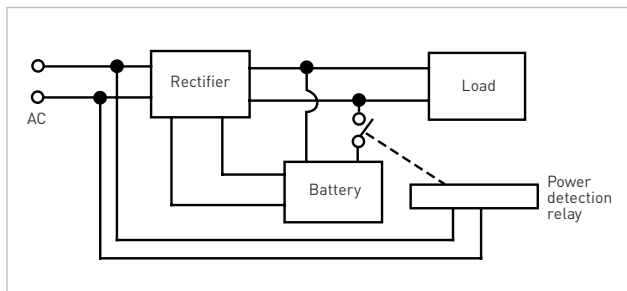
**Standby/back-up use (trickle use)**

The application load is supplied with power from AC sources in normal state. Standby/back-up use is to maintain the battery system at all times so that it can supply power to the load in case the AC input is disrupted (such as a power failure). There are two methods of charging for this use.

**a Trickle charging (compensating charging)**

In this charge system, the battery is disconnected from the load and kept charged with a small current only for compensating self-discharge while AC power is alive. In case of power failure, the battery is automatically connected to the load and battery power is supplied. This system is applied mainly as a spare power source for emergency equipment. In this use, if rapid recovery of the battery after discharge is required, it is necessary to consider the recovery charge with a comparatively large current followed by trickle charge, or alternative measures. While the type and capacity of the battery is determined by the back-up time and the load (current consumption) during power failure, some reserve power should be taken into account considering such factors as ambient temperature, capability of the charger and depth of discharge.

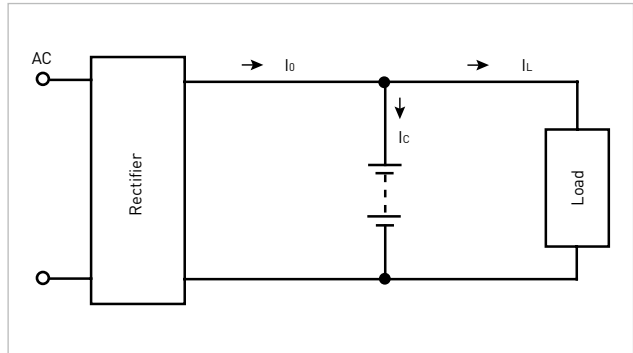
**Fig. 1** Trickle charge system model



**b Float charging**

Float system is the system in which the battery and the load are connected in parallel to the rectifier, which should supply a constant power.

**Fig. 2** Float charge system model



In the above-illustrated model, output current of the rectifier is expressed as:  $I_o = I_c + I_L$  where  $I_c$  is charge current and  $I_L$  is load current. Consideration should be given to secure adequate charging because, in fact, load current is not constant but irregular in most cases.

In the float system, capacity of the constant-voltage power source should be more than sufficient against the load. Usually, the rectifier capacity is set at the sum of the normal load current plus the current needed in order to charge the battery.

**Precautions on charging**

1. As the battery continues to be charged over a long period, a small difference in charging voltage may result in a significant difference in the battery life. Therefore, charge voltage should be controlled within a narrow range and with little variation for a long period.
2. As charge characteristics of the battery are dependent on temperature, compensation for temperature variation is required when the battery is used over a broad temperature range, and the system should be designed so that the battery and the charger are kept at the same temperature.

CHARGING METHODS AND APPLICATIONS OF VRLA BATTERIES

Application / charging method	Normal charging in 6 or more hours; constant voltage control	Constant current control
Trickle use	Control voltage: 6.8 to 6.9/6V battery 13.6 to 13.8V/12V battery	
Float use	Control voltage: 6.8 to 6.9/6V battery; 13.6 to 13.8V/12V battery. Float charging compensates for load fluctuations.	
Refresh charge (auxiliary charge)*1	When charging two or more batteries at a time, select only those which have been left under the same condition.	Charging with current of approx. 0.1CA
Application example	General uses, cellular phones (bag phones), UPS, lanterns, electric tools	

**Precautions on charging**

- (a) In constant voltage charging (cycle use): Initial current should be 0.4CA or smaller (C: rated capacity)  
(b) In constant voltage charging (trickle use): Initial current should be 0.15CA or smaller (C: rated capacity).
- Relation between standard voltage value in constant voltage charging and temperature is given in the table.

**Relation between standard voltage value in constant voltage charging and temperature**

		0°C	20°C	40°C
Cycle use	6V	7.7	7.4	7.1
	12V	15.4	14.7	14.2
Trickle use	6V	7.1	6.8	6.7
	12V	14.1	13.7	13.4

**Temperature compensation of charge voltage**

Charge voltage should be compensated to the ambient temperature near the battery, as shown by the figure below. Main reasons for the temperature compensation of charge voltage are to prevent the thermal runaway of the battery when it is used in high temperature conditions and to secure sufficient charging of the battery when it is used in low temperature conditions. Prolongation of service life of the battery by the above-described temperature compensation is expected as follows:

- At 30°C: prolonged by approx. 5%
- At 35°C: prolonged by approx. 10%
- At 40°C: prolonged by approx. 15%

In low temperature zones below 20°C, no substantial prolongation of the battery life can be expected by the temperature compensation of charge voltage.

**Charging time**

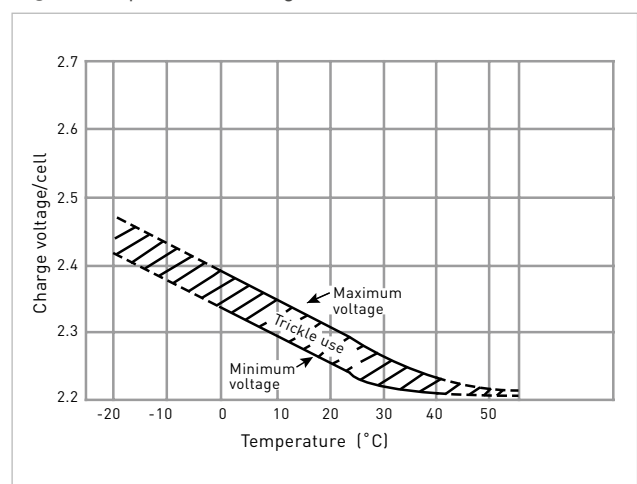
Time required to complete charging depends on factors such as depth of discharge of the battery, characteristics of the charger and ambient temperature. For cycle charge, charging time can be estimated as follows:

- If the discharge current was 0.25CA or greater:  
 $Tch = Cdis / I + (3h \text{ to } 5h)$
- If the discharge current was below 0.25CA:  
 $Tch = Cdis / I + (6h \text{ to } 10h)$ , where  
Tch: Charging time required (hours)  
Cdis: Amount of discharge before this charging (Ah)  
I: Initial charge current (A)

**Charging temperature**

- Charge the battery at an ambient temperature in the range from 0°C to 40°C.
- Optimum temperature range for charging is 5°C to 35°C.
- Charging at 0°C or below and 40°C or higher is not recommended: at low temperatures, the battery may not be charged adequately; at high temperatures, the battery may become deformed.
- For temperature compensation values, see table 'Relation between standard ...' in the left column.

**Fig. 3** Compensated voltage value



\*1 Refresh (auxiliary) charge amount should be 120 to 130% of self-discharge amount. For details, please contact us.



## VRLA battery safety test items

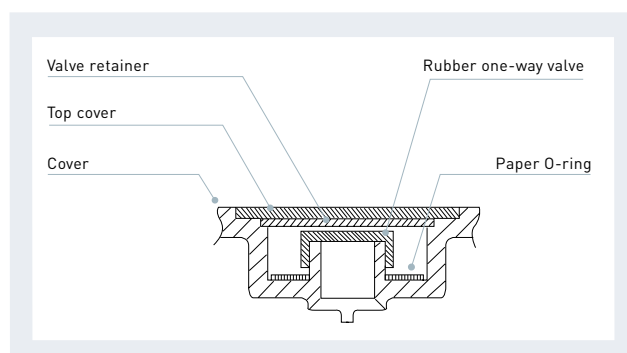
Item	Test method	Check point
<b>1. Shock test (drop test)</b> IEC 61056-1 and JIS C 8702 (These specifications are harmonized each other)	A fully charged battery is allowed to drop in the upright position from the height of 20cm onto a hard board having a thickness of 10mm or more. Test is repeated three times.	The battery should be free from noticeable breakage or leaks; and its terminal voltage should be held higher than the nominal voltage.
<b>2. Vibration test</b> IEC 61056-1 and JIS C 8702 (These specifications are harmonized each other)	A vibration frequency 1,000 times/minute and amplitude 4mm (equals 2.2g of force) is applied to the X-, Y- and Z-axis directions of a fully charged battery for 60 minutes respectively.	No battery part should be broken; the battery should be free from leaks; and its terminal voltage should be held higher than the nominal voltage.
<b>3. Oven test</b> Panasonic internal standard	A fully charged battery is left standing in an atmosphere of 70°C for 10 hours.	The battery case should not be deformed; the battery should be free from leaks.
<b>4. Coldproof test</b> Panasonic internal standard	A fully charged battery is connected to a resistor equivalent to 60 hours rate discharge and left for 4 days; then the battery is left standing in an atmosphere of -30°C for 24 hours.	No crack should develop in the battery case; the battery should be free from leaks.
<b>5. Heat cycle test</b> Panasonic internal standard	A fully charged battery is exposed to 10 cycles of 2 hours at -40°C and 2 hours at 65°C.	No crack should develop in the battery case; the battery should be free from leaks.
<b>6. Short circuit test</b> Panasonic internal standard	A fully charged battery connected with a small resistor of 10 ohms or less is allowed to discharge.	The battery must not burn nor burst.
<b>7. Large current discharge test</b> Panasonic internal standard	A fully charged battery is allowed to discharge at 3CA to 4.8V/6V battery level. (This test is not applicable to batteries having built-in thermostat.)	The battery should not burn or burst, and it should be free from battery case deformation, leaks and any irregularity internal connections.
<b>8. Vent valve function test</b> UL1989	A fully charged battery is submerged in liquid paraffin in a container, then overcharged at 0.4CA. (UL1989)	Release of gas from the vent should be observed.
<b>9. Overcharge test</b> Panasonic internal standard	A fully charged battery is overcharged at 0.1CA for 48 hours, left standing for one hour, and allowed to discharge at 0.05CA to 5.25V/6V.	No irregularity should be noticed in the battery appearance; the battery should retain 95% or more of the initial capacity.

## SAFETY DESIGN

**Vent (one way valve)**

If the internal pressure of the battery is raised to an abnormal level, the rubber one way valve opens to release excessive pressure; thus the valve protects the battery from danger of bursting. Since the rubber valve is instantly resealable, the valve can perform its function repeatedly whenever required.

**Fig. 1** Example of valve construction



VRLA batteries are inherently safe. However, there are some risks when VRLAs are used beyond a reasonable replacement time span, misapplied or abused. There are two main failure mode of VRLA battery used for trickle (float) application. In high temperatures and/or high voltage charging, dry-out is accelerated. This leads to loss of capacity and eventually the cell will fail open. Grid growth due to grid corrosion causes loss in mechanical strength and eventually leads to loss of contact with the grid. Battery should be replaced before these failures.

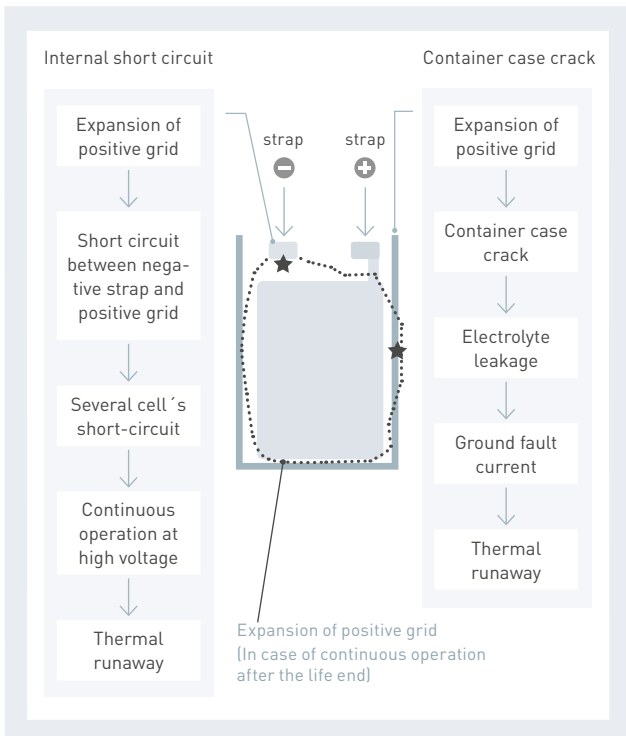
If VRLA batteries are used after the end of life, the grid growth may cause a crack of container. Capillary action can result in a slight film of conductive electrolyte forming around the crack even though VRLA batteries contain significantly lower volumes of electrolyte and the electrolyte is immobilized. This electrolyte film will be in contact with an uninsulated metal component and this ground fault current could result in thermal runaway of a portion of the string or even a fire. And the grid growth may cause internal short between positive grid and negative strap in a cell. Continuing to charge a string of cells when one or more of the cells exhibit internal shorts,

can result in thermal runaway. For example, assume a string of 12 cells is being charged at 27.3V (2.275V/cell) and the string continues in operation with two cells shorted. In this situation the average charging voltage on the remaining 10 good cells is 2.73V/cell. This will result in very high float current and cause thermal runaway. Figure 2 is the mechanism of above phenomena.

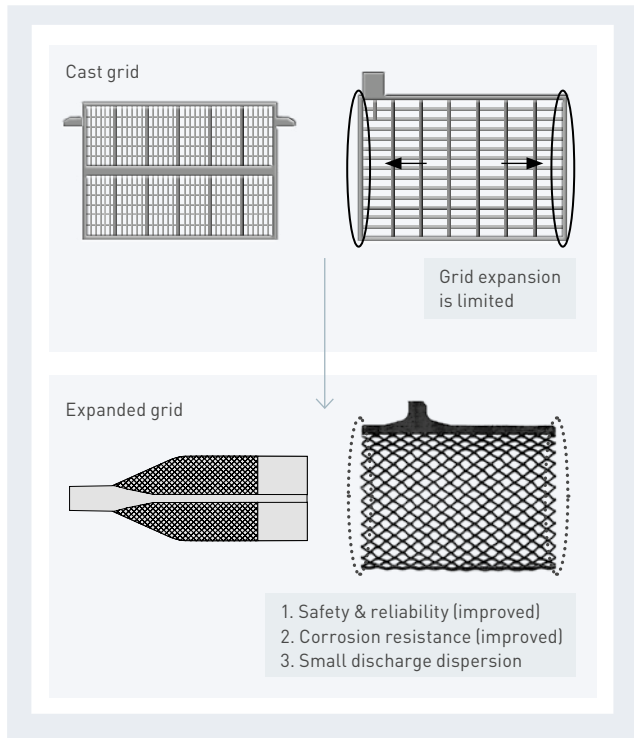
Panasonic VRLA battery minimizes these risks by using less corrosive lead alloy and expanded positive grid. Figure 3 shows an example of cast grid and expanded grid. Expanded grid does not have enough strength to crack container case by grid growth. And an insulator between positive grid and negative strap is installed in the models as necessary.

Furthermore, Panasonic uses flame-retardant battery container case for the models used for standby application. The cases are designed to be self-extinguishing and meet minimum flammability standards of UL94 V-0 and 28 L.O.I. (Limiting Oxygen Index). Figure 4 is the picture of self-extinguishing phenomenon.

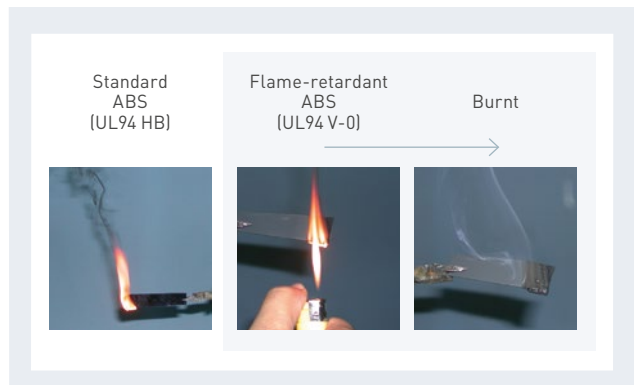
**Fig. 2** Mechanism of thermal runaway caused by grid growth



**Fig. 3** Comparison of cast grid and expanded grid

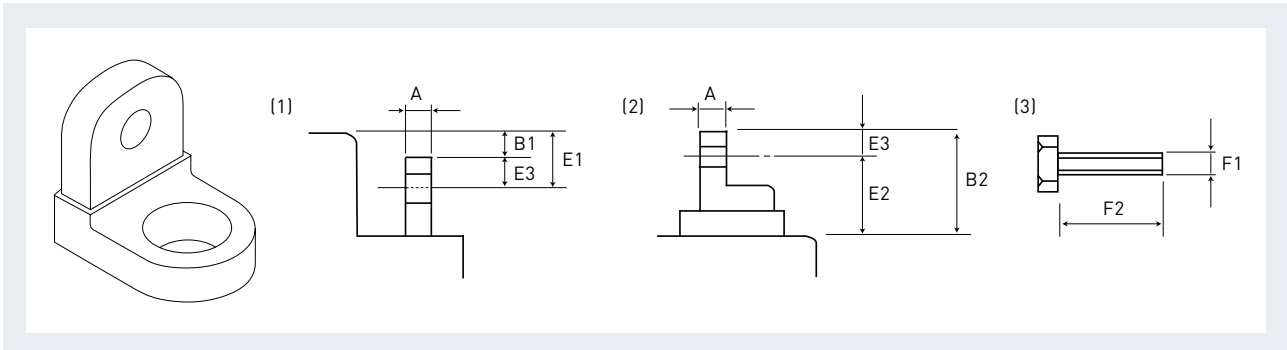


**Fig. 4** Flame-retardant case (self-extinguish phenomenon)



BOLT AND NUT TYPE

L-shape terminal (M5, M6, M8)



Type of terminal	Terminal thickness A (1)	Height from battery case top		Terminal width	Hole diameter	Hole position			Bolt		
		B1 (1)	B2 (2)			Distance from top E1 (1)	Distance from top E2 (2)	Distance from terminal top E3 (2)	Diameter F1 (3)	Pitch	Length F2 (3)
M5 bolt and nut	5.0 ± 0.3	1.0	-	11 ± 0.4	5.5 ± 0.3	6.5	-	5.5 ± 0.3	M5	P = 0.8	15 ± 1.0
M6 bolt and nut	8.0 ± 0.5	5.0	16.5 ± 1.5	16 ± 0.8	6.5 ± 0.4	-	9 ± 1.0	7.5 ± 0.4	M6	P = 1.0	20 ± 1.0
M8 bolt and nut	8.0 ± 0.5	-	24 ± 1.5	-	6.5 ± 0.4	-	14 ± 1.0	10 ± 0.4	M8	P = 1.25	20 ± 1.0

All dimensions in mm.

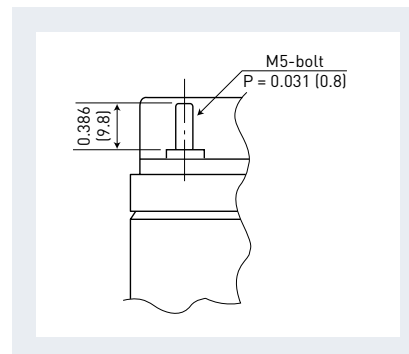
TERMINAL MATERIAL

**Bolt & nut: Lead Alloy**

(Proposition 65 Warning: Battery posts, terminals and related accessories contain lead and lead compounds, and handling this product may also expose you to Sulfuric acid mist, chemicals known to the State of California to cause cancer and reproductive harm. Wash hands after handling.)

Threaded: Tin plated steel  
all other: lead


**M5 threaded post type**



Unit: inch (mm)

## PRODUCT CERTIFICATIONS

### Alarm security market / VdS approved batteries

Model number	Nominal voltage (V)	Rated capacity (Ah)	VdS N° 	Country of origin
LC-PD1217PG/APG	12	17.0	G104101	China
LC-P1224PG/APG	12	24.0	G198049	China
LC-P1238PG/APG	12	38.0	G100002	China

### UL approved batteries

All our VRLA batteries are in compliance with UL 1989 (standby batteries) – file number MH 13723. UL 1989 requires that the battery is free from the hazard of bursting, that is, when the battery is overcharged the vent valve opens to release internal pressure.

## FACTORY CERTIFICATIONS

### ISO 9001 / ISO 14001

Quality management system (ISO 9001) defines what the organization does to ensure that its products or services satisfy the customer's quality requirements and comply with any regulations applicable to those products or services. ISO 14001 is primarily concerned with 'environmental management'. In plain language, this means what the organization does to minimize harmful effects on the environment caused by its activities.

### OHSAS 18001

OHSAS 18001 is an Occupation Health and Safety Assessment Series for health and safety management systems. It is intended to help organizations to control occupational health and safety risks. It was developed in response to widespread demand for a recognized standard against which to be certified and assessed.

## APPLICABLE STANDARDS

Following documents are established by consensus and approved by a recognized body, that provides, for common and repeated use, rules, guidelines or characteristics for activities or their results, aimed at the achievement of the optimum degree of order in a given context.

**Note:** Standards should be based on the consolidated results of science, technology and experience, and aimed at the promotion of optimum community benefits. IEC standards cover a vast range of technologies from power generation, transmission and distribution to home appliances and office equipment, semiconductors, fibre optics, batteries, solar energy, nanotechnology and marine energy as well as many others. IEC standards are also being adopted as harmonized standards by other certifying bodies such as BSI (Great Britain), CSA (Canada), UL & ANSI/INCITS (USA), SABS (South Africa),

SAI (Australia), SPC/GB (China), DIN (Germany) and JIS (Japan). IEC standards harmonized by other certifying bodies generally have some noted differences from the original IEC standard.

### JIS (Japan Industrial Standard)

All our VRLA batteries are in compliance with JIS C 8702 (almost harmonized with IEC 61056).

### IEC 61056

Specifies the general requirements, functional characteristics and methods of test for all general purpose lead acid cells and batteries of the valve regulated type for either cyclic or float charge application; in portable equipment, for instance, incorporated in tools, toys, or in static emergency, or uninterruptible power supply and general power supplies. The cells of this kind of lead acid battery may either have flat-plate electrodes in prismatic containers or have spirally wound pairs of electrodes in cylindrical containers. The sulfuric acid in these cells is immobilized between the electrodes either by absorption in a microporous structure or in a gelled form.

### IEC 61056-1

General purpose lead acid batteries (Valve-Regulated types) - part 1: general requirements, functional characteristics - methods of test

### IEC 61056-2

General purpose lead acid batteries (Valve-Regulated types) - part 2: dimensions, terminals and marking

### IEC 60896-21

Stationary lead acid batteries - part 21: Valve-Regulated types - methods of test

This part of IEC 60896 applies to all stationary lead acid cell and monobloc batteries of the Valve-Regulated type for float charge applications, (i.e. permanently connected to a load and to a d.c. power supply), in a static location, (i.e. not generally intended to be moved from place to place) and incorporated into stationary equipment or installed in battery rooms for use in telecom uninterruptible power supply (UPS), utility switching, emergency power, or similar applications.

### IEC 60896-22

Stationary lead acid batteries - part 22: Valve-Regulated types - requirements

Same as above, but defining the requirements.

Following standards are adopted as harmonized standards.

### EN 50272-2 (DIN VDE 0510 part 2)

Safety requirements for secondary batteries and battery



installations. Safety requirements for batteries and battery systems-stationary batteries. The ventilation requirements for safety rooms are specified herein. Apply the VRLA formula together with our batteries.

#### UN2800 Transport regulations

All Panasonic VRLA batteries listed in this handbook comply with ADR/IMDG SP 238 (road/sea) and IATA SP A67 and PI 806 (air). These batteries have to be handled as non-dangerous goods (non-spillable).

#### BATTERY LABEL DESIGN

- |  |  |
|--|--|
| 1 Lotcode (internal)                                 | 9 Recycling mark (US)                    |
| 2 Datecode (format YYMMDD + shift indication letter) | 10 Caution                               |
| 3 Brand name   | 11 Manufacturer name & country of origin |
| 4 Type of battery                                    | 12 China RoHS markings                   |
| 5 Model number                                       | 13 VdS marking                           |
| 6 Rated voltage & capacity                           | 14 Recognized component mark (UL mark)   |
| 7 Flame-retardant ABS (UL94 V-0) mark                | 15 Recycling mark (JP)                   |
| 8 Charging recommendation                            | 16 Recycling mark (EU)                   |



# BATTERY SELECTION

## STEPS FOR SELECTING BATTERIES ARE DESCRIBED BELOW

### Study of required specifications (draft)

Study the required specifications (draft) by checking the requirements for the battery with the battery selection criteria. Technical requirements for selecting the battery are presented below.

### Battery selection

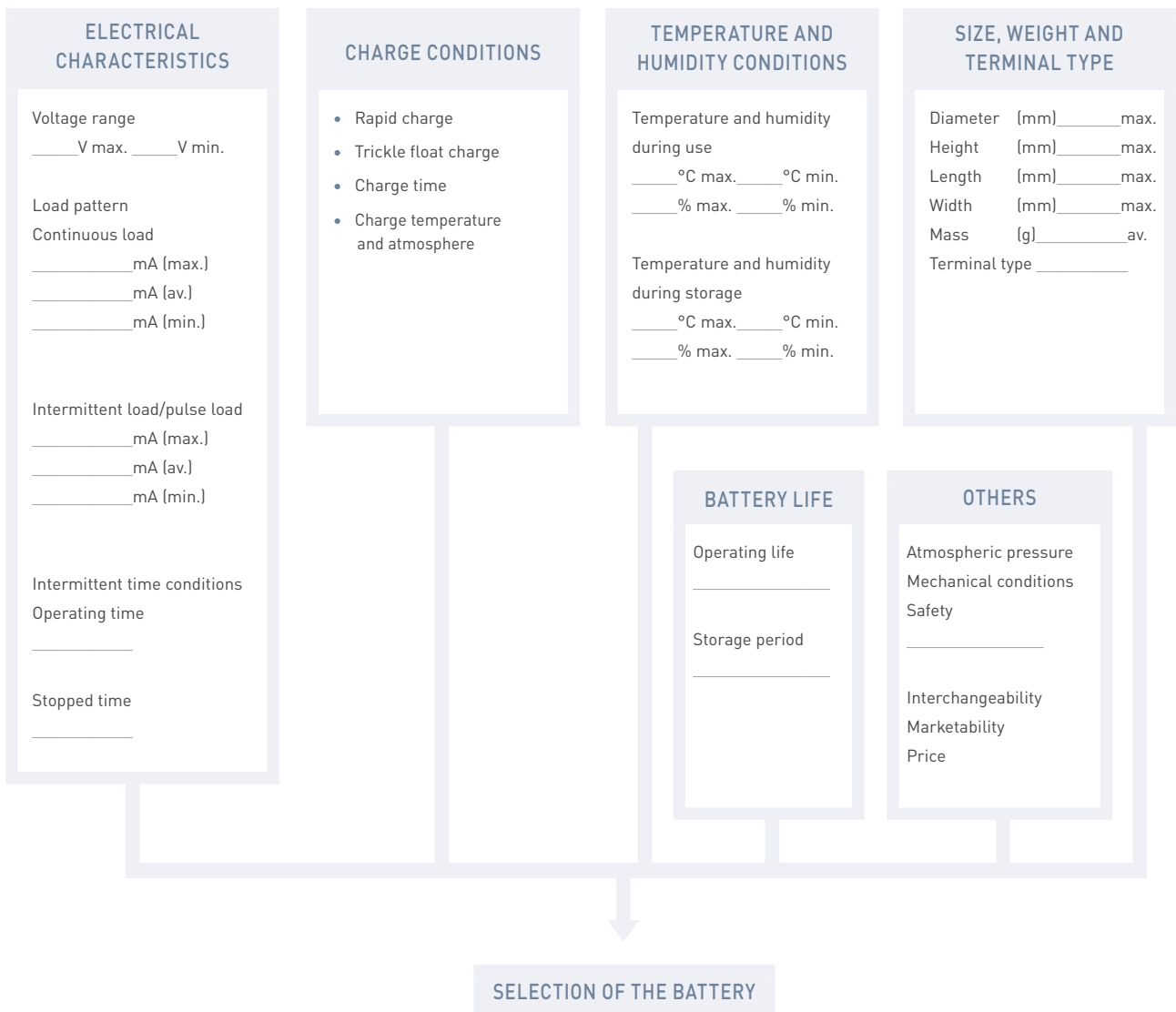
First, select several candidate batteries by referring to the technical brochures and data sheets of the batteries presently available. Then from the candidates select a battery which can meet as many of the ideal requirements as possible. In fact, however, battery selection can be seldom made so smoothly. Practically, possible removal or easing of the requirements should be considered first; then depending on the result, a proper battery should be selected from those presently available. This way of proceeding

enables economic selection of the battery. Any questions at this stage should be asked to battery engineers in depth. Sometimes, new or improved batteries which are not carried in the brochures have become available, and an appropriate battery may be found among them. Usually, required specifications are finalized at this stage.

### Request for improving or developing batteries

If no battery which will satisfy special requirements can be found by the approach described above, requests for improving or developing new batteries should be made to our technical department, and these requests should be coordinated as quickly as possible to allow enough time for studying: the study takes usually 6 to 12 months or even longer depending on the request. In this section, guidelines for selecting appropriate batteries for specific equipment were mentioned. If further information regarding the battery selection is required, please contact us.

## TECHNOLOGICAL FACTORS CONCERNING BATTERY SELECTION





## LC-P SERIES – TRICKLE DESIGN LIFE 10-12 YEARS

These batteries feature a stable performance and have been designed with safety in mind. Furthermore, they are equipped with a flame-retardant battery container (ABS UL94 V-0) and some battery types are obtainable with different terminals. They are widely used in back-up systems, energy storage systems, etc.

### FEATURES

- State-of-the-art Absorbed Glass Mat (AGM) technology
- Superior design and low voltage spread
- Enhanced lifespan due to excellent recombination efficiency
- Highest quality control standards
- Almost 50 years of experience in production
- Selected batteries with flame-retardant battery containers according to UL94 V-0
- Various VdS approved batteries

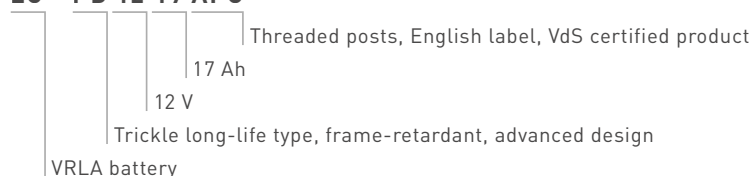
### APPLICATIONS

- UPS
- Communication infrastructure
- Alarm systems
- Medical equipment
- Emergency lights, etc.

Model number	Nominal voltage (V)	Nominal capacity (Ah) 20 hours rate	Length (mm)	Width (mm)	Total height (mm)	Weight (kg)	VdS number	Page
LC-PD1217PG/APG	12	17.0	76	181	167	5.45	G104101	28
LC-P1220P/AP	12	20.0	76	181	167	5.90	-	30
LC-P1224PG/APG	12	24.0	125	165	179.5/175	8.05	G198049	32
LC-P1228P/AP	12	28.0	125	165	179.5/175	9.40	-	34
LC-P1238PG/APG	12	38.0	165	197	180/175	12.5	G100002	36
LC-P1242P/AP	12	42.0	165	197	180/175	13.5	-	38
LC-P1275P	12	75	166	350	175	21.5	-	40
LC-P12120P	12	120	173	407	236	34.5	-	42
LC-P12150BP*1	12	150	183	532	214	43.0	-	44
LC-P12200BP*1	12	200	237	533	216	57.0	-	46

### MODEL NUMBER (EXAMPLE)

#### LC - PD 12 17 APG



\*1 This battery is equipped with insert terminals.

# LC-PD1217PG/APG

FOR STANDBY POWER SUPPLIES.  
 EXPECTED TRICKLE LIFE: 6 YEARS AT 25°C,  
 10 YEARS AT 20°C.

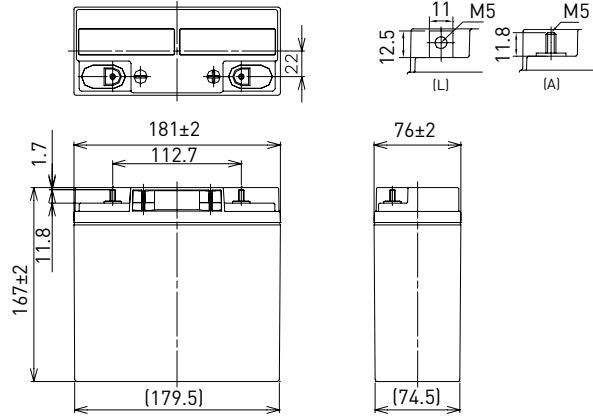


G104101

DIMENSIONS (MM)



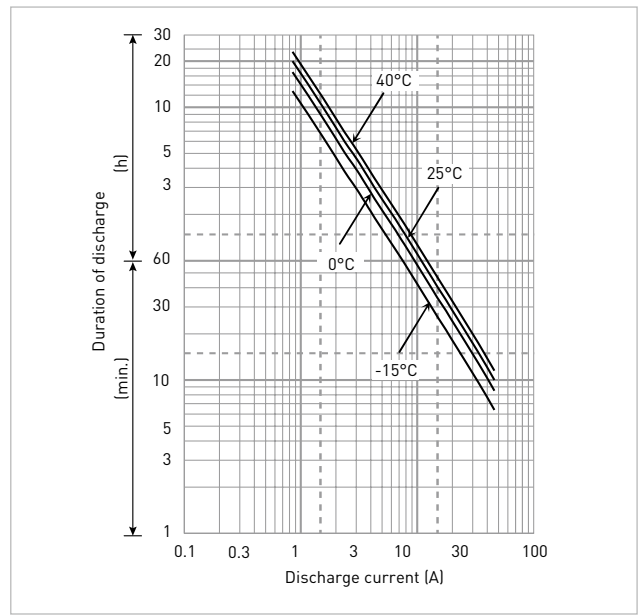
Terminal type (option)



Contents indicated (including the recycle marking, etc.) are subject to change without notice. Battery case resin: Flame-retardant (UL94V-0).

Specifications		LC-PD1217PG/APG
<b>Nominal voltage (V)</b>		12
<b>Nominal capacity</b>	<b>20 hours rate (Ah)</b>	17.0
<b>Dimensions</b>	<b>Length (mm)</b>	181
	<b>Width (mm)</b>	76
	<b>Total height (mm)</b>	167
<b>Approx. mass (kg)</b>		5.45
<b>Terminal type</b>	M5 bolt/nut & threaded post	
<b>Capacity (25°C)</b>	<b>20 hours rate (Ah)</b>	17.0
	<b>10 hours rate (Ah)</b>	16.0
	<b>3 hours rate (Ah)</b>	13.0
	<b>1 hour rate (Ah)</b>	11.0
<b>Impedance (mΩ)</b>	<b>Fully charged battery (25°C)</b>	
	17	
<b>Temperature dependency of capacity (%) – 20 hours rate</b>	<b>40°C</b>	102
	<b>25°C</b>	100
	<b>0°C</b>	85
	<b>-15°C</b>	65
<b>Remaining capacity (25°C)</b>	<b>After 3 months (%)</b>	91
	<b>After 6 months (%)</b>	82
	<b>After 12 months (%)</b>	64

DURATION OF DISCHARGE VS. DISCHARGE CURRENT



WATT TABLE (25°C)

(Wattage/battery)

Cut-off	5min.	10min.	15min.	20min.	30min.	45min.	1h	1.5h	2h	3h	4h	5h	6h	10h	20h
9.6V	806	526	402	337	251	177	142	97.6	75.5	56.2	43.2	35.6	28.6	19.0	10.3
9.9V	756	516	399	331	249	176	140	95.6	74.9	55.9	42.9	35.4	28.5	18.9	10.3
10.2V	708	502	391	326	246	175	139	93.7	73.0	55.4	42.6	35.1	28.3	18.7	10.2
10.5V	634	465	364	309	240	172	136	91.7	70.4	54.5	42.3	34.8	28.0	18.6	10.2
10.8V	561	415	339	301	232	169	134	89.2	67.1	53.4	41.8	33.9	27.5	18.4	10.1

AMPERE TABLE (25°C)

(Ampere/battery)

Cut-off	5min.	10min.	15min.	20min.	30min.	45min.	1h	1.5h	2h	3h	4h	5h	6h	10h	20h
9.6V	72.2	47.0	37.7	29.0	21.5	15.1	12.0	8.26	6.37	4.72	3.61	2.97	2.39	1.65	0.857
9.9V	67.8	46.0	36.9	28.6	21.2	15.0	11.9	8.10	6.33	4.70	3.59	2.95	2.38	1.64	0.855
10.2V	63.5	44.9	35.5	28.1	21.0	14.9	11.7	7.93	6.16	4.65	3.57	2.93	2.36	1.63	0.852
10.5V	56.9	41.6	34.8	26.7	20.5	14.6	11.6	7.77	5.95	4.58	3.54	2.90	2.33	1.62	0.850
10.8V	50.3	37.1	34.1	26.0	19.8	14.4	11.3	7.56	5.67	4.49	3.49	2.83	2.29	1.60	0.845

All mentioned values are average values

# LC-PD1217PG/APG

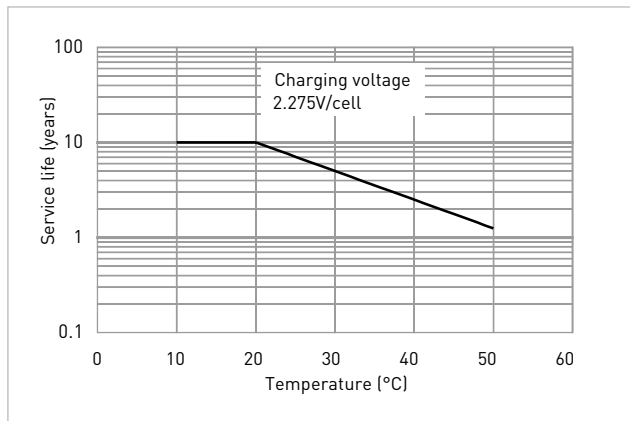
## CHARGING METHOD (25°C)

<b>Trickle use</b>	Control voltage: 13.6V - 13.8V Initial current: 2.55A or smaller
--------------------	---

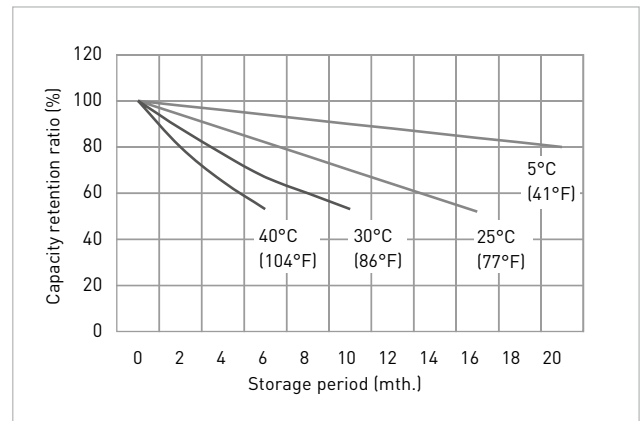
## CUT-OFF VOLTAGE

<b>Discharge current</b>	0.850A - 3.40A	3.40A - 8.50A	8.50A - 17.0A	17.0A - 34.0A	34.0A - 51.0A
<b>Cut-off voltage</b>	10.5V	10.2V	9.9V	9.3V	8.7V

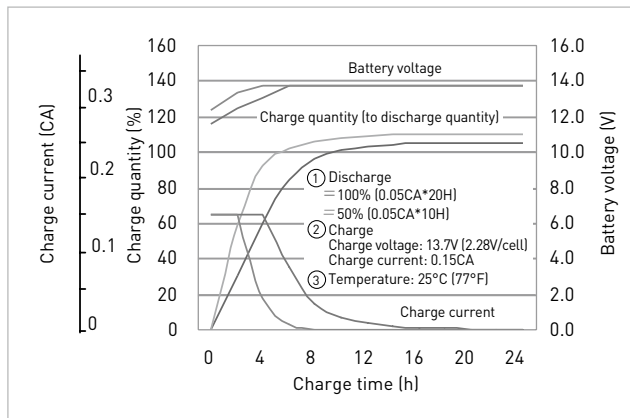
## INFLUENCE OF TEMPERATURE ON TRICKLE LIFE



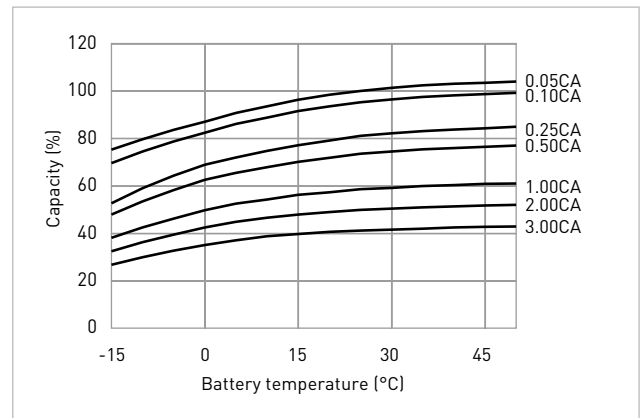
## RESIDUAL CAPACITY TEST RESULT



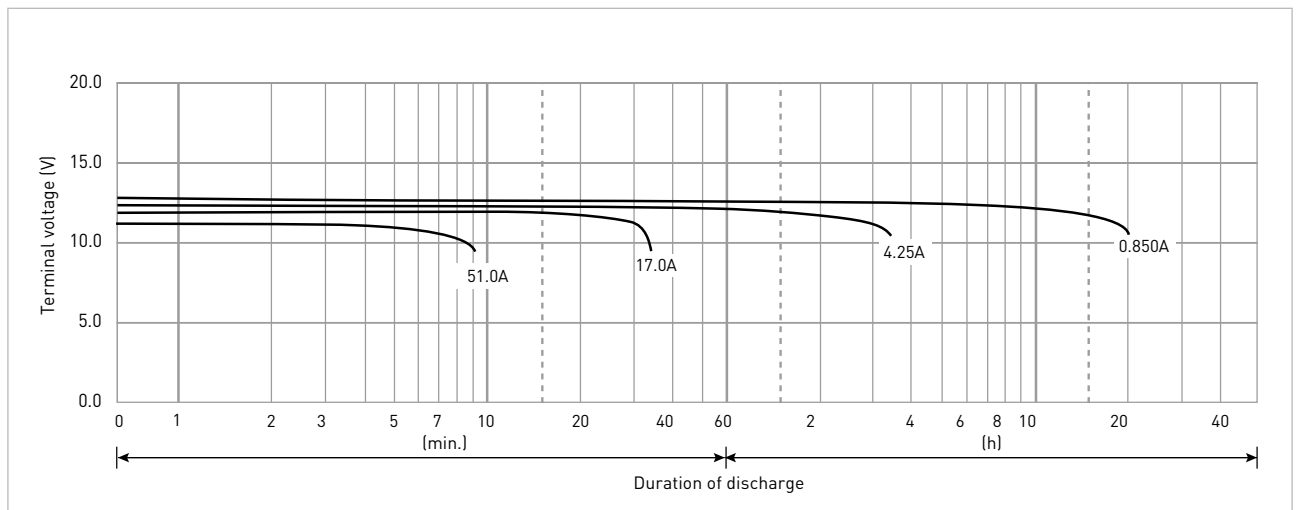
## CONSTANT-VOLTAGE CONSTANT-CURRENT CHARGE CHARACTERISTICS FOR TRICKLE USE



## DISCHARGE CAPACITY BY TEMPERATURE AND BY DISCHARGE CURRENT



## DISCHARGE CHARACTERISTICS



Due to the potential energy stored in the batteries, Please read 'Precautions for handling the Rechargeable Valve Regulated Lead Acid Batteries' before using batteries. If improper handling or use of the batteries without understanding 'Precautions for handling the Rechargeable Valve Regulated Lead Acid Batteries' may result in bodily injury caused by electrolyte leakage, heat generation, or explosion.

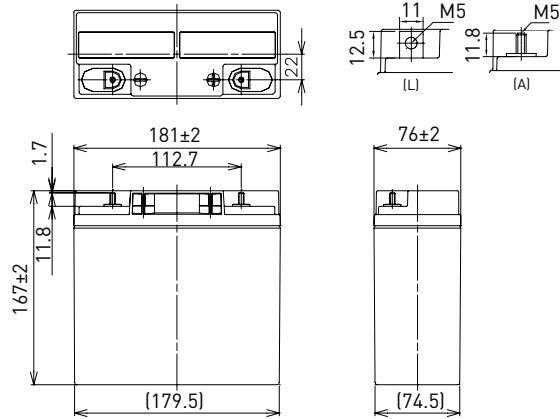
# LC-P1220P/AP

FOR STANDBY POWER SUPPLIES.  
EXPECTED TRICKLE DESIGN LIFE: 10 - 12 YEARS AT 20°C  
ACCORDING TO EUROBAT.

## DIMENSIONS (MM)



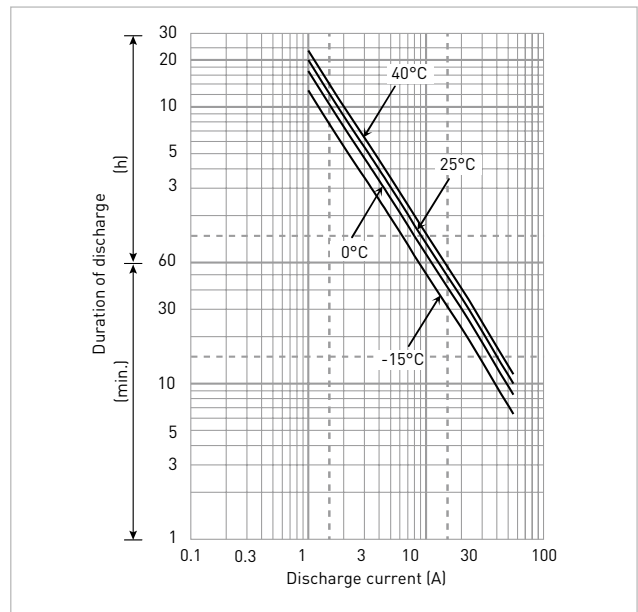
Terminal type (option)



Contents indicated (including the recycle marking, etc.) are subject to change without notice. Battery case resin: flame-retardant (UL94 V-0)

Specifications		LC-P1220P/AP
<b>Nominal voltage (V)</b>		12
<b>Nominal capacity</b>	<b>20 hours rate (Ah)</b>	20.0
<b>Dimensions</b>	<b>Length (mm)</b>	76
	<b>Width (mm)</b>	181
	<b>Total height (mm)</b>	167
<b>Approx. mass (kg)</b>		5.90
<b>Terminal type</b>	M5 bolt/nut & threaded post	
<b>Capacity (25°C)</b>	<b>20 hours rate (Ah)</b>	20.0
	<b>10 hours rate (Ah)</b>	17.0
	<b>3 hours rate (Ah)</b>	15.0
	<b>1 hour rate (Ah)</b>	12.0
<b>Impedance (mΩ)</b>	<b>Fully charged battery (25°C)</b>	15
<b>Temperature dependency of capacity (%) - 20 hours rate</b>	<b>40°C</b>	102
	<b>25°C</b>	100
	<b>0°C</b>	85
	<b>-15°C</b>	65
<b>Remaining capacity (25°C)</b>	<b>After 3 months (%)</b>	91
	<b>After 6 months (%)</b>	82
	<b>After 12 months (%)</b>	64

## DURATION OF DISCHARGE VS. DISCHARGE CURRENT



## WATT TABLE (25°C)

(Wattage/battery)

Cut-off	5min.	10min.	15min.	20min.	30min.	45min.	1h	1.5h	2h	3h	4h	5h	6h	10h	20h
9.6V	853	557	425	357	266	188	150	103	83.1	61.9	47.5	39.2	31.5	21.6	11.7
9.9V	800	546	423	351	263	186	148	101	82.5	61.5	47.2	38.9	31.4	21.5	11.7
10.2V	750	532	414	345	260	185	146	99.1	80.3	60.9	46.9	38.6	31.2	21.3	11.6
10.5V	672	493	385	328	254	182	145	97.0	77.5	60.0	46.6	38.3	30.8	21.2	11.6
10.8V	594	440	359	319	246	179	141	94.3	73.9	58.8	46.0	37.4	30.3	21.0	11.5

## AMPERE TABLE (25°C)

(Ampere/battery)

Cut-off	5min.	10min.	15min.	20min.	30min.	45min.	1h	1.5h	2h	3h	4h	5h	6h	10h	20h
9.6V	85.0	55.3	40.0	34.2	24.0	16.9	12.7	9.04	6.98	5.17	3.95	3.26	2.61	1.75	1.01
9.9V	79.7	54.2	39.7	33.6	23.7	16.8	12.6	8.86	6.92	5.14	3.93	3.23	2.60	1.75	1.01
10.2V	74.7	52.8	38.9	33.1	23.5	16.6	12.4	8.68	6.74	5.09	3.90	3.20	2.58	1.73	1.00
10.5V	66.9	48.9	36.2	31.4	22.9	16.4	12.2	8.50	6.51	5.01	3.88	3.18	2.55	1.72	1.00
10.8V	59.2	43.6	33.8	30.6	22.2	16.1	12.0	8.27	6.20	4.91	3.82	3.10	2.51	1.70	0.994

All mentioned values are average values

# LC-P1220P/AP

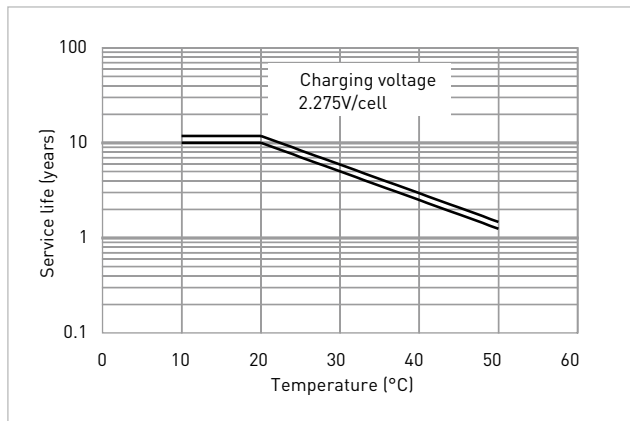
## CHARGING METHOD (25°C)

<b>Trickle use</b>	Control voltage: 13.6V - 13.8V Initial current: 3.00A or smaller
--------------------	---

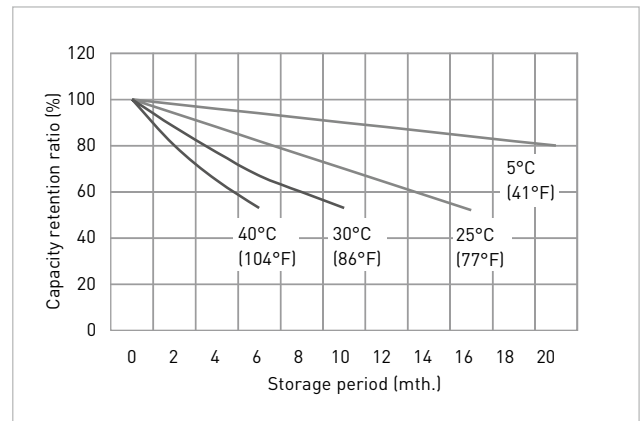
## CUT-OFF VOLTAGE

<b>Discharge current</b>	1.00A - 4.00A	4.00A - 10.0A	10.0A - 20.0A	20.0A - 40.0A	40.0A - 60.0A
<b>Cut-off voltage</b>	10.5V	10.2V	9.9V	9.3V	8.7V

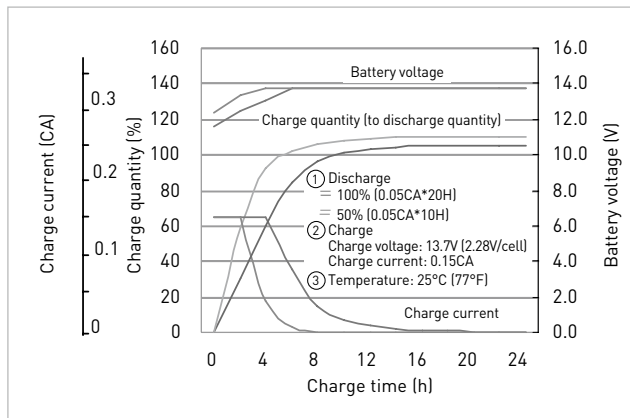
## INFLUENCE OF TEMPERATURE ON TRICKLE LIFE



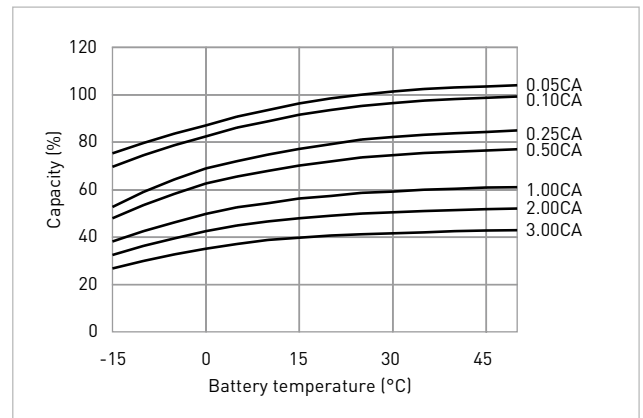
## RESIDUAL CAPACITY TEST RESULT



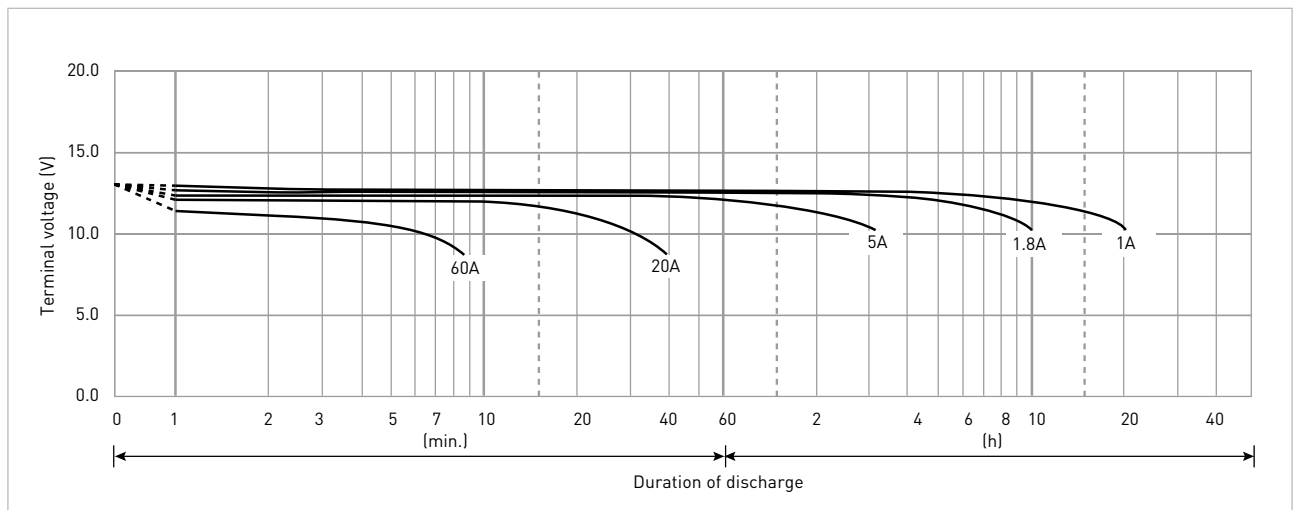
## CONSTANT-VOLTAGE CONSTANT-CURRENT CHARGE CHARACTERISTICS FOR TRICKLE USE



## DISCHARGE CAPACITY BY TEMPERATURE AND BY DISCHARGE CURRENT



## DISCHARGE CHARACTERISTICS



# LC-P1224PG/APG

FOR STANDBY POWER SUPPLIES.  
EXPECTED TRICKLE DESIGN LIFE: 10 - 12 YEARS  
AT 20°C ACCORDING TO EUROBAT.



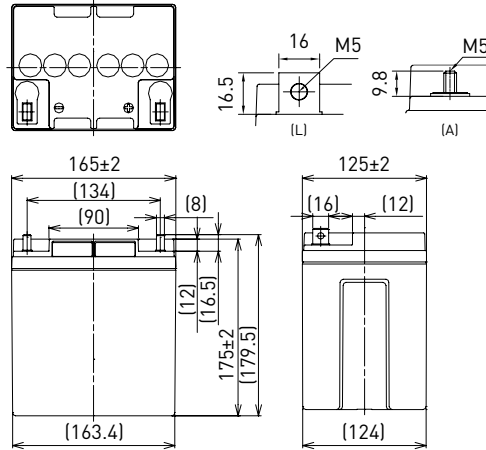
G198049

## DIMENSIONS (MM)



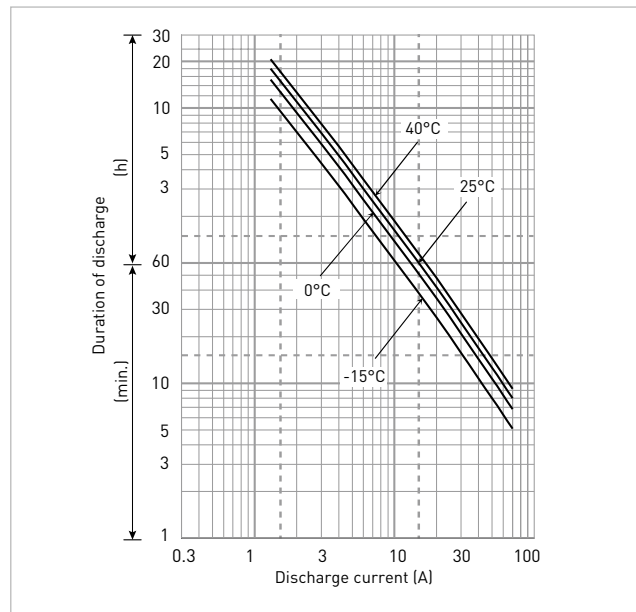
Contents indicated (including the recycle marking, etc.) are subject to change without notice. Battery case resin: flame-retardant (UL94 V-0)

Terminal type (option)



Specifications		LC-P1224PG/APG
<b>Nominal voltage (V)</b>		12
<b>Nominal capacity</b>	<b>20 hours rate (Ah)</b>	24.0
<b>Dimensions</b>	<b>Length (mm)</b>	125
	<b>Width (mm)</b>	165
	<b>Total height (mm)</b>	179.5/175
<b>Approx. mass (kg)</b>		8.05
<b>Terminal type</b>	M5 bolt/nut & threaded post	
<b>Capacity (25°C)</b>	<b>20 hours rate (Ah)</b>	24.0
	<b>10 hours rate (Ah)</b>	22.0
	<b>3 hours rate (Ah)</b>	18.0
	<b>1 hour rate (Ah)</b>	14.0
<b>Impedance (mΩ)</b>	<b>Fully charged battery (25°C)</b>	11
<b>Temperature dependency of capacity (%) - 20 hours rate</b>	<b>40°C</b>	102
	<b>25°C</b>	100
	<b>0°C</b>	85
	<b>-15°C</b>	65
<b>Remaining capacity (25°C)</b>	<b>After 3 months (%)</b>	91
	<b>After 6 months (%)</b>	82
	<b>After 12 months (%)</b>	64

## DURATION OF DISCHARGE VS. DISCHARGE CURRENT



## WATT TABLE (25°C)

(Wattage/battery)

Cut-off	5min.	10min.	15min.	20min.	30min.	45min.	1h	1.5h	2h	3h	4h	5h	6h	10h	20h
9.6V	992	739	523	441	317	234	183	118	104	73.8	58.6	47.9	40.8	26.4	14.6
9.9V	931	724	520	434	314	232	181	116	103	73.4	58.2	47.5	40.6	26.3	14.6
10.2V	872	706	509	426	310	230	179	113	101	72.7	57.8	47.2	40.3	26.0	14.5
10.5V	782	654	474	405	303	226	175	111	97.2	71.6	57.4	46.8	39.8	25.9	14.4
10.8V	691	583	442	394	293	223	172	108	92.6	70.1	56.6	45.6	39.2	25.6	14.3

## AMPERE TABLE (25°C)

(Ampere/battery)

Cut-off	5min.	10min.	15min.	20min.	30min.	45min.	1h	1.5h	2h	3h	4h	5h	6h	10h	20h
9.6V	89.0	66.0	45.5	38.0	27.1	19.9	14.6	10.0	8.80	6.20	4.90	3.89	3.40	2.27	1.23
9.9V	83.5	64.7	45.2	37.4	26.8	19.8	14.5	9.80	8.73	6.17	4.87	3.86	3.39	2.26	1.22
10.2V	78.2	63.0	44.3	36.8	26.5	19.6	14.3	9.60	8.51	6.11	4.84	3.83	3.36	2.23	1.21
10.5V	70.1	58.4	41.2	34.9	25.9	19.3	14.0	9.40	8.21	6.01	4.80	3.80	3.32	2.22	1.20
10.8V	62.0	52.1	38.4	34.0	25.0	19.0	13.7	9.14	7.82	5.89	4.74	3.71	3.27	2.20	1.19

All mentioned values are average values



# LC-P1224PG/APG

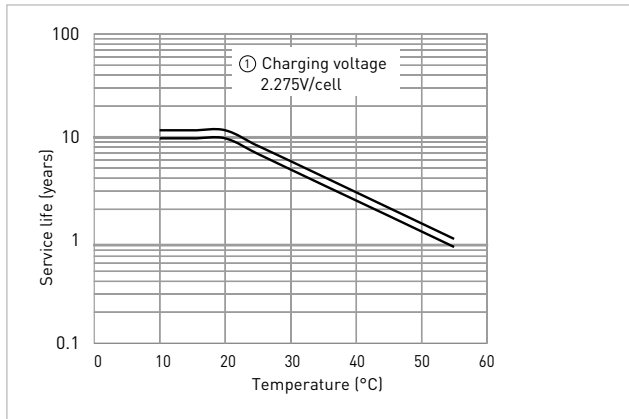
## CHARGING METHOD (25°C)

<b>Trickle use</b>	Control voltage: 13.6V - 13.8V
	Initial current: 3.6A or smaller

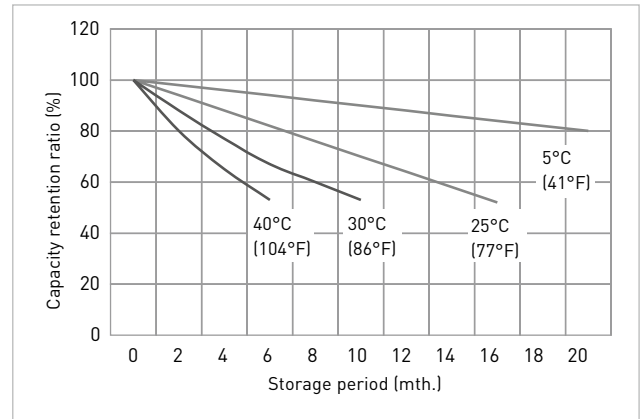
## CUT-OFF VOLTAGE

<b>Discharge current</b>	1.2A - 4.8A	4.8A - 12A	12A - 24A	24A - 48A	48A - 72A
<b>Cut-off voltage</b>	10.5V	10.2V	9.9V	9.3V	8.7V

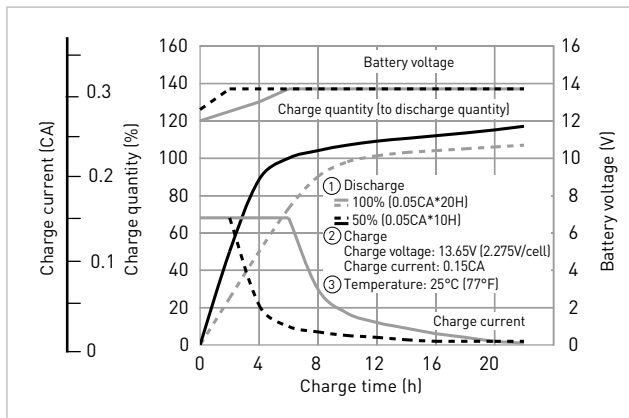
## INFLUENCE OF TEMPERATURE ON TRICKLE LIFE



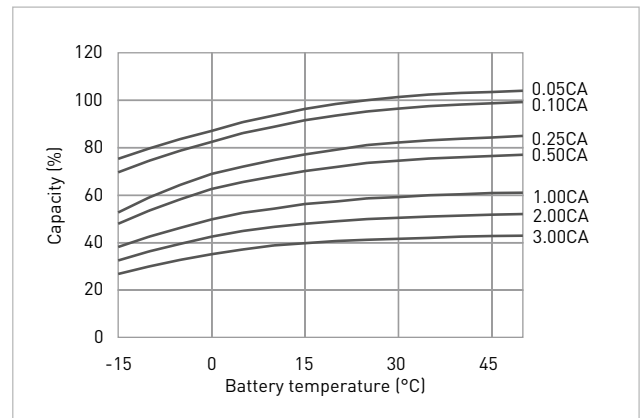
## RESIDUAL CAPACITY VS. STORAGE PERIOD



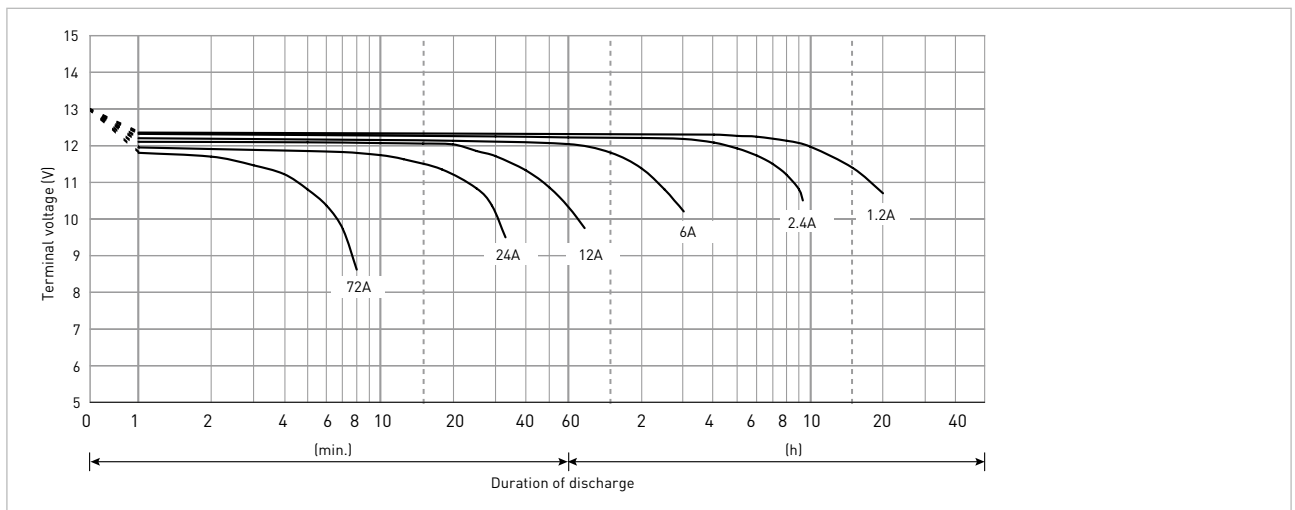
## CONSTANT-VOLTAGE CONSTANT-CURRENT CHARGE CHARACTERISTICS FOR TRICKLE USE



## DISCHARGE CAPACITY BY TEMPERATURE AND BY DISCHARGE CURRENT



## DISCHARGE CHARACTERISTICS



# LC-P1228P/AP

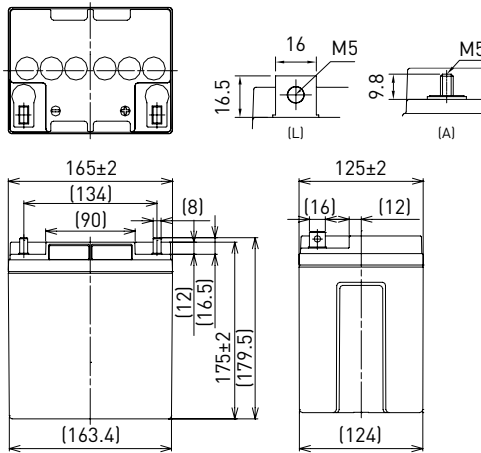
FOR STANDBY POWER SUPPLIES.  
 EXPECTED TRICKLE DESIGN LIFE: 10 - 12 YEARS AT 20°C  
 ACCORDING TO EUROBAT.

## DIMENSIONS (MM)



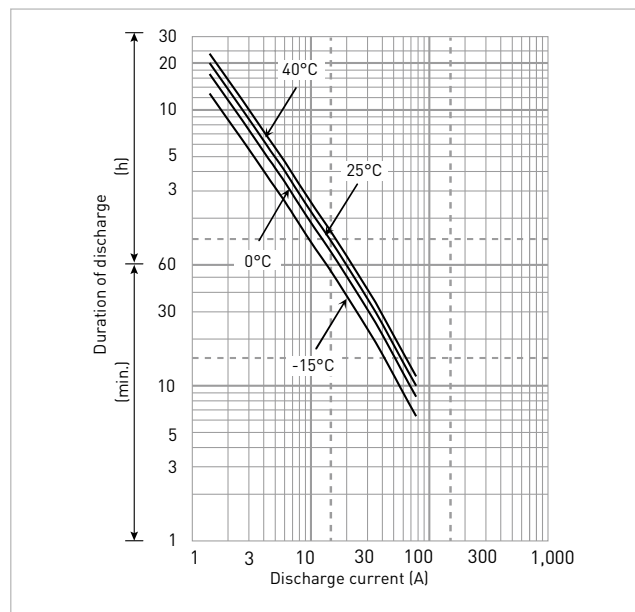
Contents indicated (including the recycle marking, etc.) are subject to change without notice. Battery case resin: flame-retardant (UL94 V-0)

Terminal type (option)



Specifications		LC-P1228P/AP
<b>Nominal voltage (V)</b>		12
<b>Nominal capacity</b>	<b>20 hours rate (Ah)</b>	28.0
<b>Dimensions</b>	<b>Length (mm)</b>	125
	<b>Width (mm)</b>	165
	<b>Total height (mm)</b>	179.5/175
<b>Approx. mass (kg)</b>		9.40
<b>Terminal type</b>	M5 bolt/nut & threaded post	
<b>Capacity (25°C)</b>	<b>20 hours rate (Ah)</b>	28.0
	<b>10 hours rate (Ah)</b>	26.0
	<b>3 hours rate (Ah)</b>	22.0
	<b>1 hour rate (Ah)</b>	21.0
<b>Impedance (mΩ)</b>	<b>Fully charged battery (25°C)</b>	11
<b>Temperature dependency of capacity (%) - 20 hours rate</b>	<b>40°C</b>	102
	<b>25°C</b>	100
	<b>0°C</b>	85
	<b>-15°C</b>	65
<b>Remaining capacity (25°C)</b>	<b>After 3 months (%)</b>	91
	<b>After 6 months (%)</b>	82
	<b>After 12 months (%)</b>	64

## DURATION OF DISCHARGE VS. DISCHARGE CURRENT



## WATT TABLE (25°C)

(Wattage/battery)

Cut-off	5min.	10min.	15min.	20min.	30min.	45min.	1h	1.5h	2h	3h	4h	5h	6h	10h	20h
9.6V	1,160	865	664	585	410	304	260	159	129	91.6	74.1	61.1	50.8	31.8	16.8
9.9V	1,093	849	654	579	404	294	254	156	128	90.4	72.9	60.8	50.4	31.8	16.8
10.2V	1,026	818	643	567	397	288	251	155	127	89.3	71.7	60.5	49.9	31.8	16.8
10.5V	976	784	621	545	386	282	247	154	126	88.1	71.1	60.2	49.5	31.8	16.8
10.8V	903	773	610	539	374	255	218	149	118	84.5	70.5	59.9	49.0	31.8	16.8

## AMPERE TABLE (25°C)

(Ampere/battery)

Cut-off	5min.	10min.	15min.	20min.	30min.	45min.	1h	1.5h	2h	3h	4h	5h	6h	10h	20h
9.6V	104	77.2	57.7	50.4	35.0	25.9	22.1	13.5	10.9	7.70	6.20	5.10	4.30	2.60	1.40
9.9V	98.0	75.8	56.9	49.9	34.5	25.0	21.6	13.2	10.8	7.60	6.10	5.06	4.28	2.60	1.40
10.2V	92.0	73.0	55.9	48.9	33.9	24.5	21.3	13.1	10.7	7.50	6.00	5.03	4.25	2.60	1.40
10.5V	87.5	70.0	54.0	47.0	33.0	24.0	21.0	13.0	10.6	7.40	5.95	4.99	4.23	2.60	1.40
10.8V	81.0	69.0	53.0	46.5	32.0	21.7	18.5	12.6	10.0	7.10	5.90	4.95	4.20	2.60	1.40

All mentioned values are average values

# LC-P1228P/AP

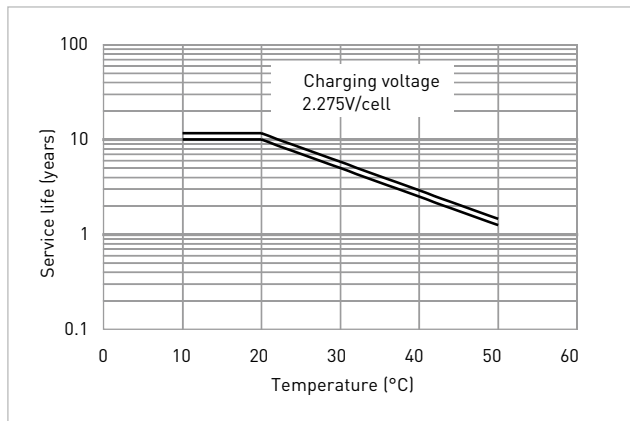
## CHARGING METHOD (25°C)

<b>Trickle use</b>	Control voltage: 13.6V - 13.8V Initial current: 4.20A or smaller
--------------------	---

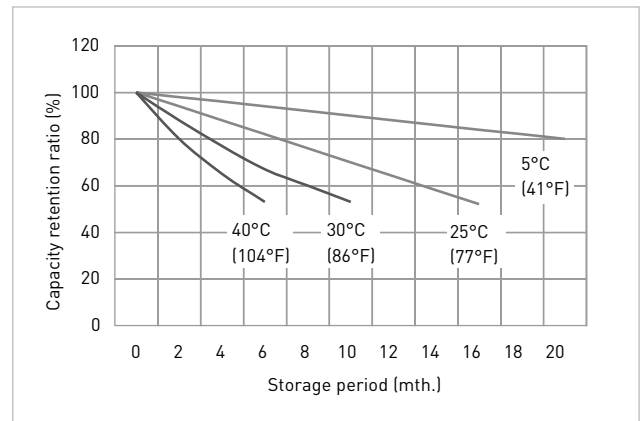
## CUT-OFF VOLTAGE

<b>Discharge current</b>	1.40A - 5.60A	5.60A - 14.0A	14.0A - 28.0A	28.0A - 56.0A	56.0A - 84A
<b>Cut-off voltage</b>	10.5V	10.2V	9.9V	9.3V	8.7V

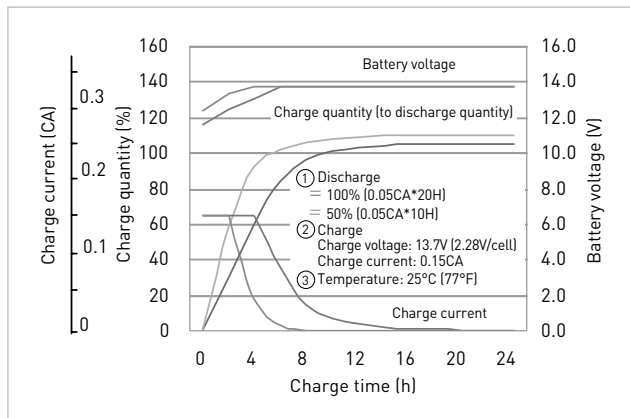
## INFLUENCE OF TEMPERATURE ON TRICKLE LIFE



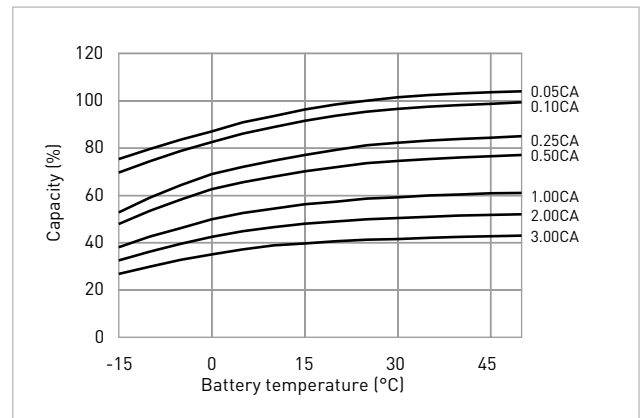
## RESIDUAL CAPACITY TEST RESULT



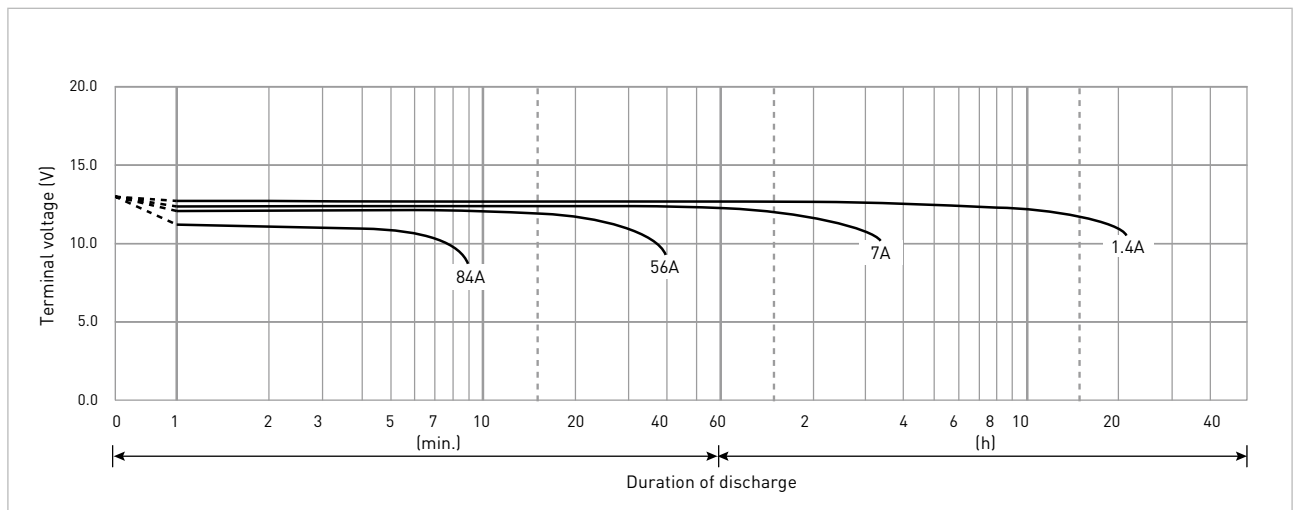
## CONSTANT-VOLTAGE CONSTANT-CURRENT CHARGE CHARACTERISTICS FOR TRICKLE USE



## DISCHARGE CAPACITY BY TEMPERATURE AND BY DISCHARGE CURRENT



## DISCHARGE CHARACTERISTICS



# LC-P1238PG/APG

FOR STANDBY POWER SUPPLIES.  
EXPECTED TRICKLE DESIGN LIFE: 10 - 12 YEARS  
AT 20°C ACCORDING TO EUROBAT.

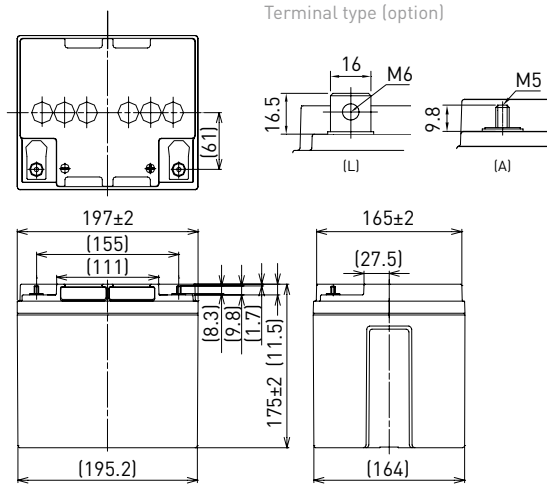


G100002

## DIMENSIONS (MM)

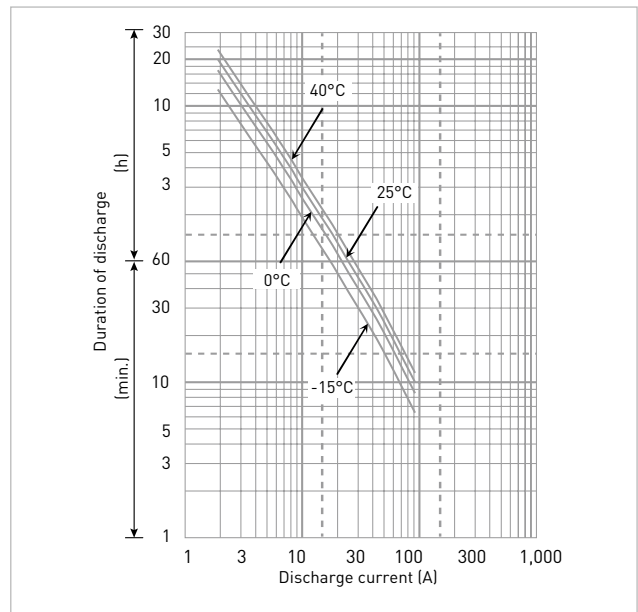


Contents indicated (including the recycle marking, etc.) are subject to change without notice. Battery case resin: flame-retardant (UL94 V-0)



Specifications		LC-P1238PG/APG
<b>Nominal voltage (V)</b>		12
<b>Nominal capacity</b>	<b>20 hours rate (Ah)</b>	38.0
<b>Dimensions</b>	<b>Length (mm)</b>	165
	<b>Width (mm)</b>	197
	<b>Total height (mm)</b>	180/175
<b>Approx. mass (kg)</b>		12.5
<b>Terminal type</b>	M6 bolt/nut & M5 threaded post	
<b>Capacity (25°C)</b>	<b>20 hours rate (Ah)</b>	38.0
	<b>10 hours rate (Ah)</b>	36.0
	<b>3 hours rate (Ah)</b>	29.0
	<b>1 hour rate (Ah)</b>	23.0
<b>Impedance (mΩ)</b>	<b>Fully charged battery (25°C)</b>	10
<b>Temperature dependency of capacity [%] - 20 hours rate</b>	<b>40°C</b>	102
	<b>25°C</b>	100
	<b>0°C</b>	85
	<b>-15°C</b>	65
<b>Remaining capacity (25°C)</b>	<b>After 3 months (%)</b>	91
	<b>After 6 months (%)</b>	82
	<b>After 12 months (%)</b>	64

## DURATION OF DISCHARGE VS. DISCHARGE CURRENT



## WATT TABLE (25°C)

(Wattage/battery)

Cut-off	5min.	10min.	15min.	20min.	30min.	45min.	1h	1.5h	2h	3h	4h	5h	6h	10h	20h
9.6V	1,349	1,030	800	686	505	351	276	214	169	123	99.2	77.9	68.3	42.0	22.8
9.9V	1,271	1,008	788	682	500	350	269	209	168	120	98.0	76.7	68.0	42.0	22.8
10.2V	1,204	980	768	672	489	349	267	185	167	119	96.8	75.5	67.7	42.0	22.8
10.5V	1,126	952	748	661	480	346	265	183	166	117	95.6	74.9	67.4	42.0	22.8
10.8V	1,098	874	716	640	468	308	247	175	155	114	94.4	74.3	67.1	42.0	22.8

## AMPERE TABLE (25°C)

(Ampere/battery)

Cut-off	5min.	10min.	15min.	20min.	30min.	45min.	1h	1.5h	2h	3h	4h	5h	6h	10h	20h
9.6V	121	92.0	69.6	59.1	43.2	29.9	23.4	18.1	14.3	10.3	8.30	6.50	5.70	3.60	1.90
9.9V	114	90.0	68.5	58.8	42.7	29.8	22.8	17.7	14.2	10.1	8.20	6.40	5.68	3.60	1.90
10.2V	108	87.5	66.8	57.9	41.8	29.7	22.7	15.7	14.1	10.0	8.10	6.30	5.66	3.60	1.90
10.5V	101	85.0	65.0	57.0	41.0	29.5	22.5	15.5	14.0	9.80	8.00	6.25	5.64	3.60	1.90
10.8V	98.5	78.0	62.3	55.2	40.0	26.2	21.0	14.8	13.1	9.60	7.90	6.20	5.60	3.60	1.90

All mentioned values are average values

# LC-P1238PG/APG

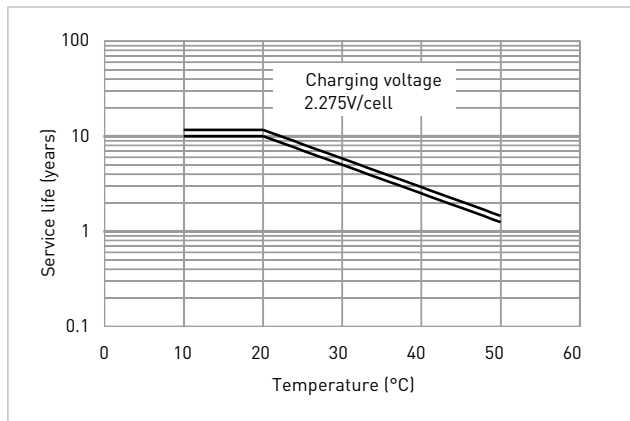
## CHARGING METHOD (25°C)

<b>Trickle use</b>	Control voltage: 13.6V - 13.8V Initial current: 5.70A or smaller
--------------------	---

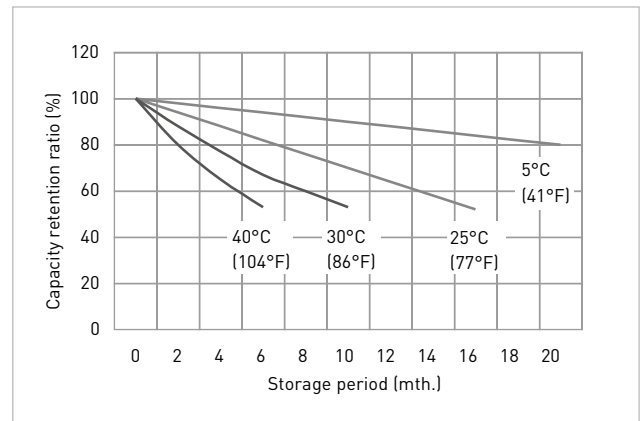
## CUT-OFF VOLTAGE

<b>Discharge current</b>	1.90A - 7.60A	7.60A - 19.0A	19.0A - 38.0A	38.0A - 76.0A	76.0A - 114A
<b>Cut-off voltage</b>	10.5V	10.2V	9.9V	9.3V	8.7V

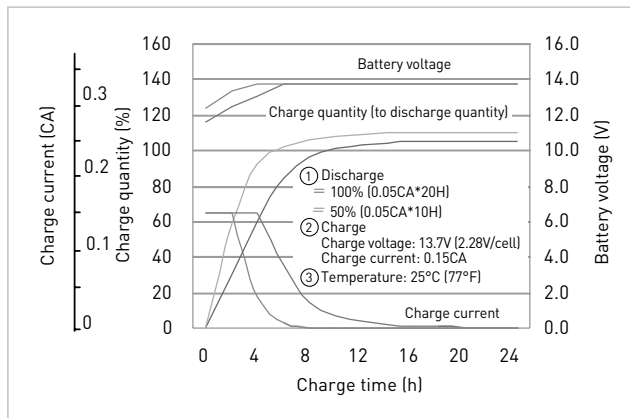
## INFLUENCE OF TEMPERATURE ON TRICKLE LIFE



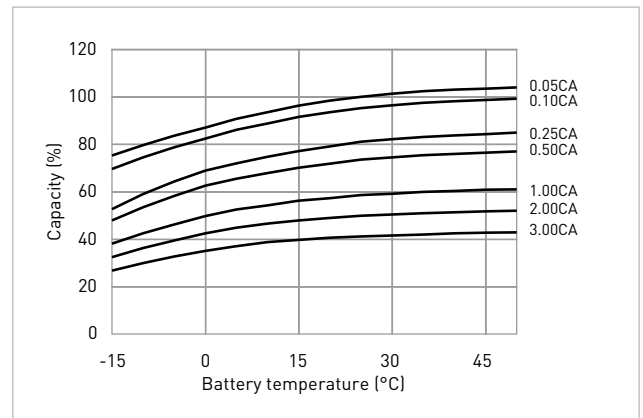
## RESIDUAL CAPACITY TEST RESULT



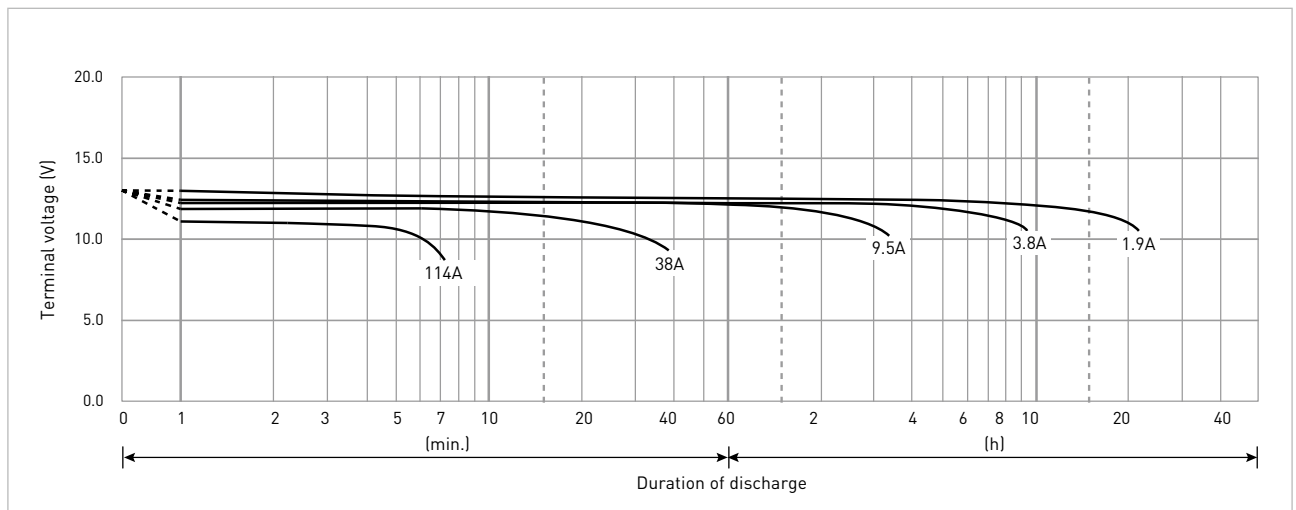
## CONSTANT-VOLTAGE CONSTANT-CURRENT CHARGE CHARACTERISTICS FOR TRICKLE USE



## DISCHARGE CAPACITY BY TEMPERATURE AND BY DISCHARGE CURRENT



## DISCHARGE CHARACTERISTICS



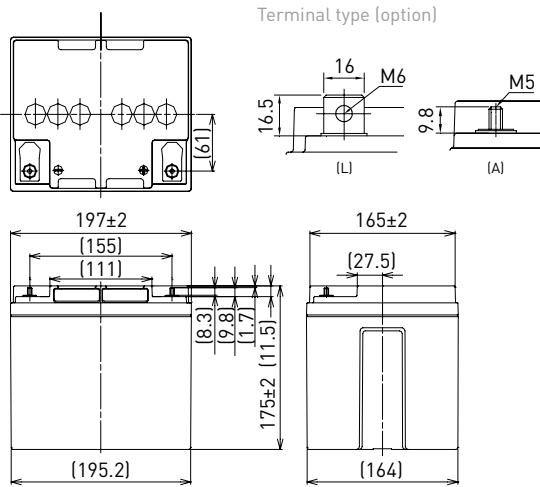
# LC-P1242P/AP

## DIMENSIONS (MM)



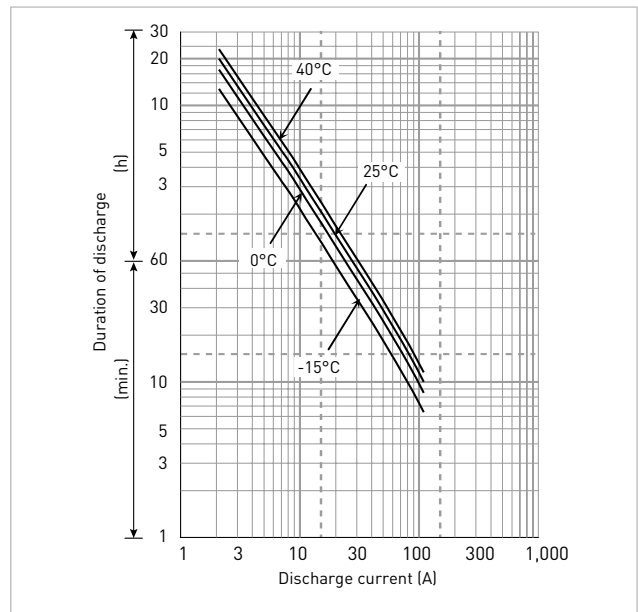
Contents indicated (including the recycle marking, etc.) are subject to change without notice. Battery case resin: flame-retardant (UL94 V-0)

FOR STANDBY POWER SUPPLIES.  
EXPECTED TRICKLE DESIGN LIFE: 10 - 12 YEARS AT 20°C  
ACCORDING TO EUROBAT.



Specifications		LC-P1242P/AP
<b>Nominal voltage (V)</b>		12
<b>Nominal capacity</b>	<b>20 hours rate (Ah)</b>	42.0
<b>Dimensions</b>	<b>Length (mm)</b>	165
	<b>Width (mm)</b>	197
	<b>Total height (mm)</b>	180/175
<b>Approx. mass (kg)</b>		13.5
<b>Terminal type</b>	M6 bolt/nut & M5 threaded post	
<b>Capacity (25°C)</b>	<b>20 hours rate (Ah)</b>	42.0
	<b>10 hours rate (Ah)</b>	40.0
	<b>3 hours rate (Ah)</b>	32.0
	<b>1 hour rate (Ah)</b>	26.0
<b>Impedance (mΩ)</b>	<b>Fully charged battery (25°C)</b>	10
<b>Temperature dependency of capacity (%) - 20 hours rate</b>	<b>40°C</b>	102
	<b>25°C</b>	100
	<b>0°C</b>	85
	<b>-15°C</b>	65
<b>Remaining capacity (25°C)</b>	<b>After 3 months (%)</b>	91
	<b>After 6 months (%)</b>	82
	<b>After 12 months (%)</b>	64

## DURATION OF DISCHARGE VS. DISCHARGE CURRENT



## WATT TABLE (25°C)

(Wattage/battery)

Cut-off	5min.	10min.	15min.	20min.	30min.	45min.	1h	1.5h	2h	3h	4h	5h	6h	10h	20h
9.6V	1,483	1,254	966	835	625	410	312	241	187	132	110	89.9	79.1	48.0	25.2
9.9V	1,405	1,232	955	824	607	407	310	234	186	130	109	89.4	78.5	48.0	25.2
10.2V	1,327	1,210	943	812	596	406	307	217	184	127	108	88.9	77.9	48.0	25.2
10.5V	1,249	1,176	920	800	585	405	306	211	179	126	107	88.5	76.7	48.0	25.2
10.8V	1,215	1,086	886	777	573	390	295	201	173	121	105	87.5	75.5	48.0	25.2

## AMPERE TABLE (25°C)

(Ampere/battery)

Cut-off	5min.	10min.	15min.	20min.	30min.	45min.	1h	1.5h	2h	3h	4h	5h	6h	10h	20h
9.6V	133	112	84.0	72.0	53.4	34.9	26.5	20.4	15.8	11.1	9.20	7.50	6.60	4.00	2.10
9.9V	126	110	83.0	71.0	51.9	34.7	26.3	19.8	15.7	10.9	9.10	7.46	6.50	4.00	2.10
10.2V	119	108	82.0	70.0	50.9	34.6	26.1	18.4	15.5	10.7	9.00	7.42	6.50	4.00	2.10
10.5V	112	105	80.0	69.0	50.0	34.5	26.0	17.9	15.1	10.6	8.90	7.38	6.40	4.00	2.10
10.8V	109	97.0	77.0	67.0	49.0	33.2	25.0	17.0	14.6	10.2	8.80	7.30	6.30	4.00	2.10

All mentioned values are average values

# LC-P1242P/AP

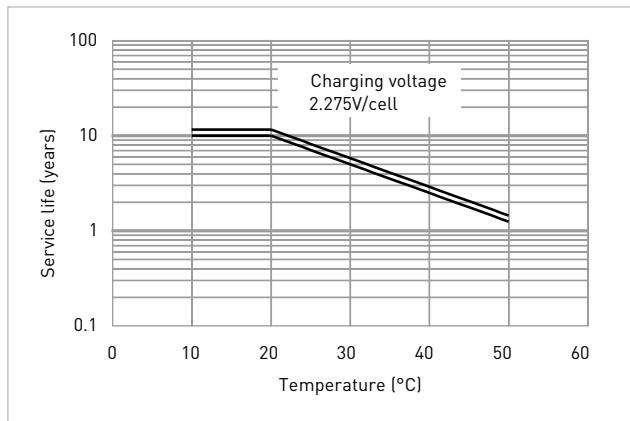
## CHARGING METHOD (25°C)

<b>Trickle use</b>	Control voltage: 13.6V - 13.8V Initial current: 6.30A or smaller
--------------------	---

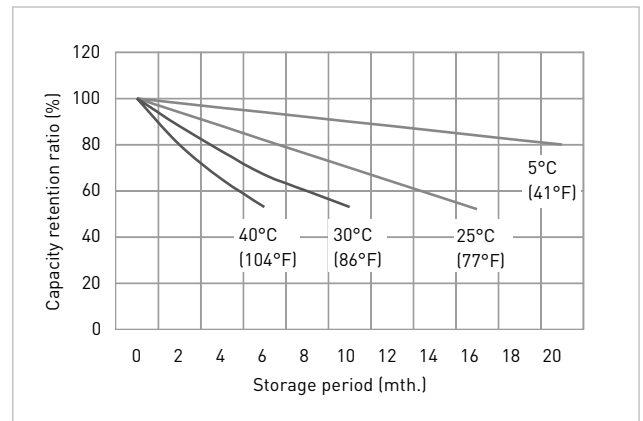
## CUT-OFF VOLTAGE

<b>Discharge current</b>	2.10A - 8.40A	8.40A - 21.0A	21.0A - 42.0A	42.0A - 84.0A	84.0A - 126A
<b>Cut-off voltage</b>	10.5V	10.2V	9.9V	9.3V	8.7V

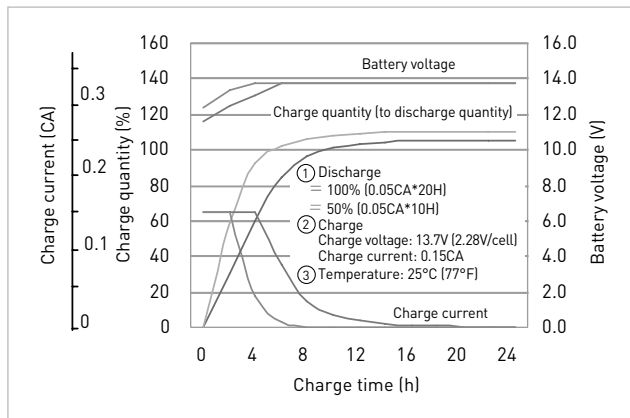
## INFLUENCE OF TEMPERATURE ON TRICKLE LIFE



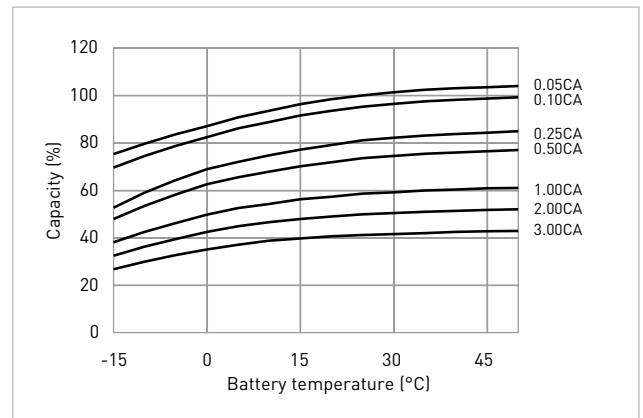
## RESIDUAL CAPACITY TEST RESULT



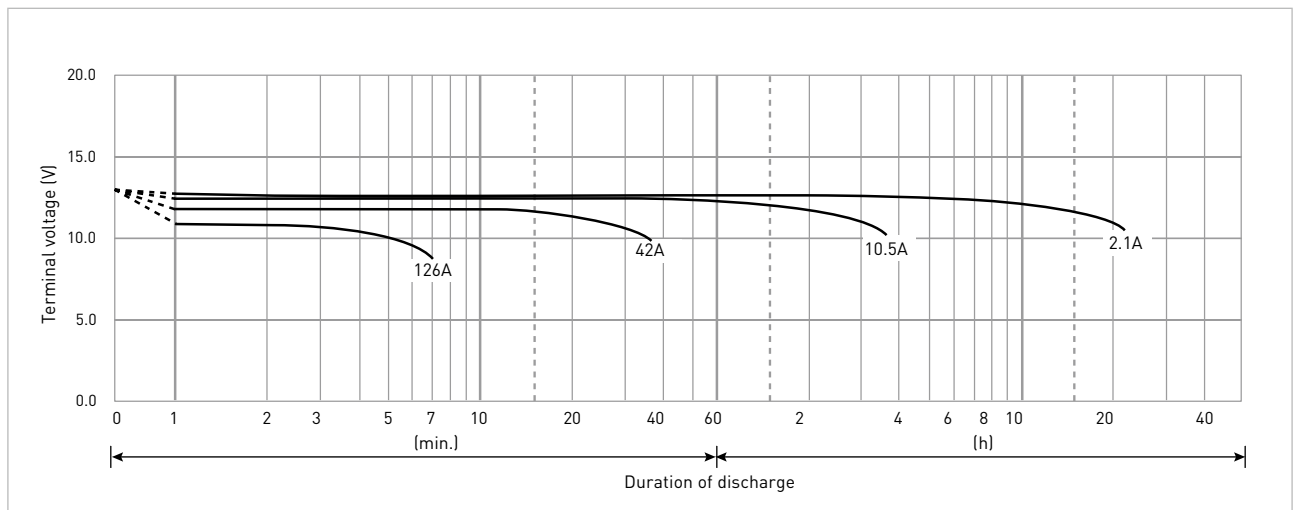
## CONSTANT-VOLTAGE CONSTANT-CURRENT CHARGE CHARACTERISTICS FOR TRICKLE USE



## DISCHARGE CAPACITY BY TEMPERATURE AND BY DISCHARGE CURRENT



## DISCHARGE CHARACTERISTICS



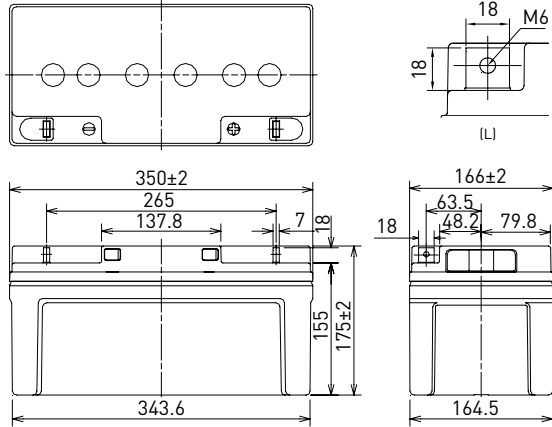
# LC-P1275P

FOR STANDBY POWER SUPPLIES.  
EXPECTED TRICKLE DESIGN LIFE: 10 - 12 YEARS AT 20°C  
ACCORDING TO EUROBAT.

## DIMENSIONS (MM)



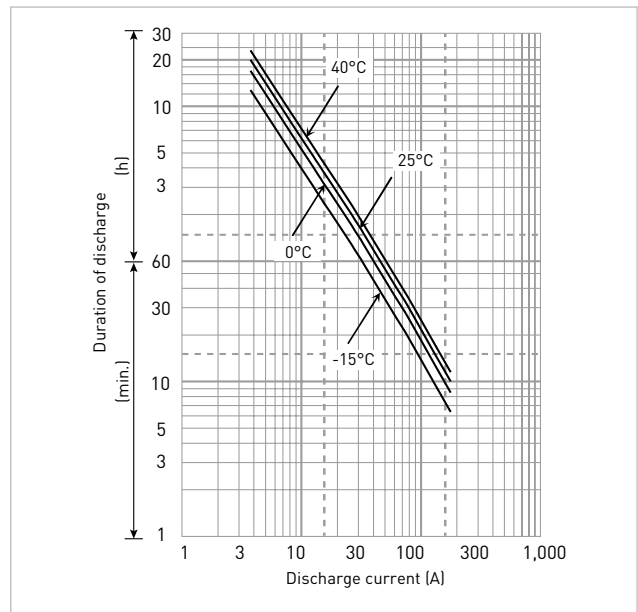
Terminal type



Contents indicated (including the recycle marking, etc.) are subject to change without notice. Battery case resin: flame-retardant (UL94 V-0)

Specifications		LC-P1275P
<b>Nominal voltage (V)</b>		12
<b>Nominal capacity</b>	<b>20 hours rate (Ah)</b>	75
<b>Dimensions</b>	<b>Length (mm)</b>	166
	<b>Width (mm)</b>	350
	<b>Total height (mm)</b>	175
<b>Approx. mass (kg)</b>		21.5
<b>Terminal type</b>		M6 bolt/nut
<b>Capacity (25°C)</b>	<b>20 hours rate (Ah)</b>	75
	<b>10 hours rate (Ah)</b>	70
	<b>3 hours rate (Ah)</b>	53.0
	<b>1 hour rate (Ah)</b>	50.0
<b>Impedance (mΩ)</b>	<b>Fully charged battery (25°C)</b>	7
<b>Temperature dependency of capacity (%) - 20 hours rate</b>	<b>40°C</b>	102
	<b>25°C</b>	100
	<b>0°C</b>	85
	<b>-15°C</b>	65
<b>Remaining capacity (25°C)</b>	<b>After 3 months (%)</b>	91
	<b>After 6 months (%)</b>	82
	<b>After 12 months (%)</b>	64

## DURATION OF DISCHARGE VS. DISCHARGE CURRENT



## WATT TABLE (25°C)

(Wattage/battery)

Cut-off	5min.	10min.	15min.	20min.	30min.	45min.	1h	1.5h	2h	3h	4h	5h	6h	10h	20h
9.6V	2,273	1,985	1,546	1,313	962	702	555	411	327	220	171	149	125	79.5	45.0
9.9V	2,233	1,950	1,538	1,306	955	683	553	403	325	216	169	147	124	79.1	45.0
10.2V	2,093	1,827	1,531	1,290	940	679	549	400	321	215	168	146	123	78.6	45.0
10.5V	1,875	1,637	1,446	1,230	925	671	546	395	317	210	166	144	122	78.2	45.0
10.8V	1,657	1,447	1,400	1,200	911	580	473	355	301	205	164	143	120	77.8	44.1

## AMPERE TABLE (25°C)

(Ampere/battery)

Cut-off	5min.	10min.	15min.	20min.	30min.	45min.	1h	1.5h	2h	3h	4h	5h	6h	10h	20h
9.6V	241	177	134	116	86.9	61.5	51.0	34.8	27.6	18.5	14.3	12.4	10.4	7.14	3.75
9.9V	237	175	132	113	86.3	59.9	50.8	34.1	27.4	18.2	14.2	12.2	10.3	7.11	3.75
10.2V	222	167	130	111	84.9	59.5	50.5	33.8	27.1	18.1	14.0	12.1	10.2	7.07	3.75
10.5V	199	159	126	109	83.6	58.9	50.2	33.4	26.8	17.7	13.9	12.0	10.1	7.04	3.75
10.8V	176	151	122	106	82.3	50.8	43.5	30.1	25.4	17.3	13.7	11.9	10.0	7.00	3.68

All mentioned values are average values



# LC-P1275P

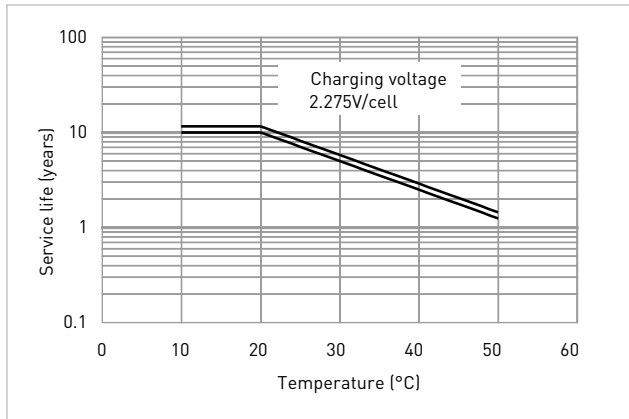
## CHARGING METHOD (25°C)

<b>Trickle use</b>	Control voltage: 13.6V - 13.8V Initial current: 11.3A or smaller
--------------------	---

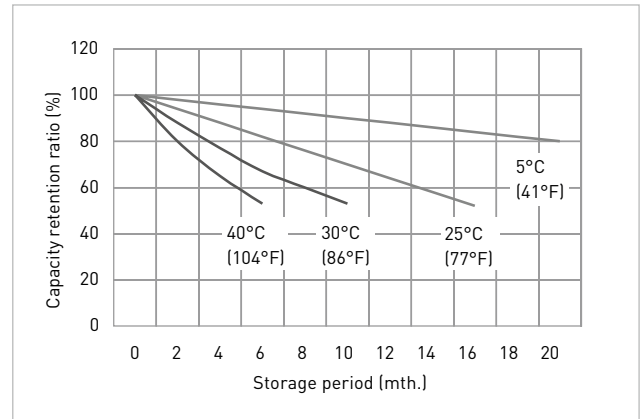
## CUT-OFF VOLTAGE

<b>Discharge current</b>	3.75A - 15.0A	15.0A - 37.5A	37.5A - 75.0A	75.0A - 150A	150A - 225A
<b>Cut-off voltage</b>	10.5V	10.2V	9.9V	9.3V	8.7V

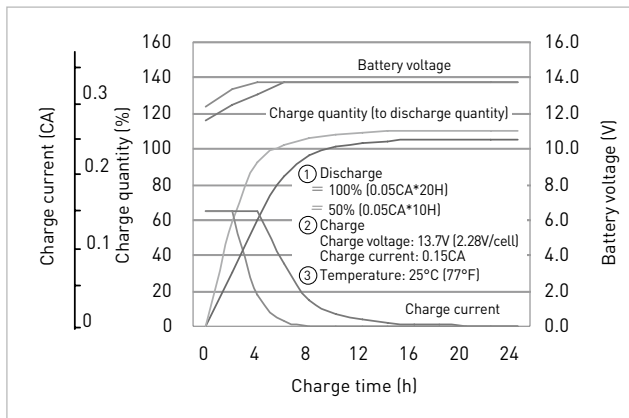
## INFLUENCE OF TEMPERATURE ON TRICKLE LIFE



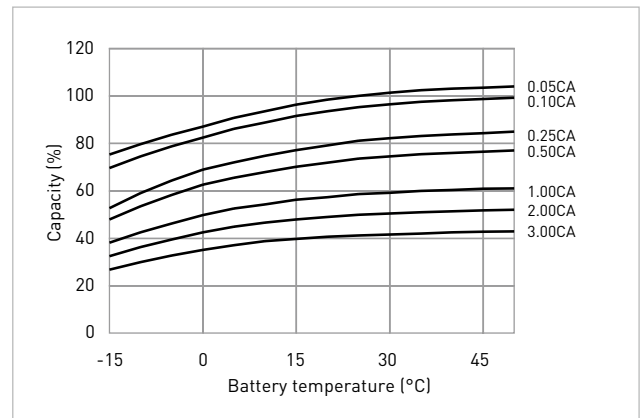
## RESIDUAL CAPACITY TEST RESULT



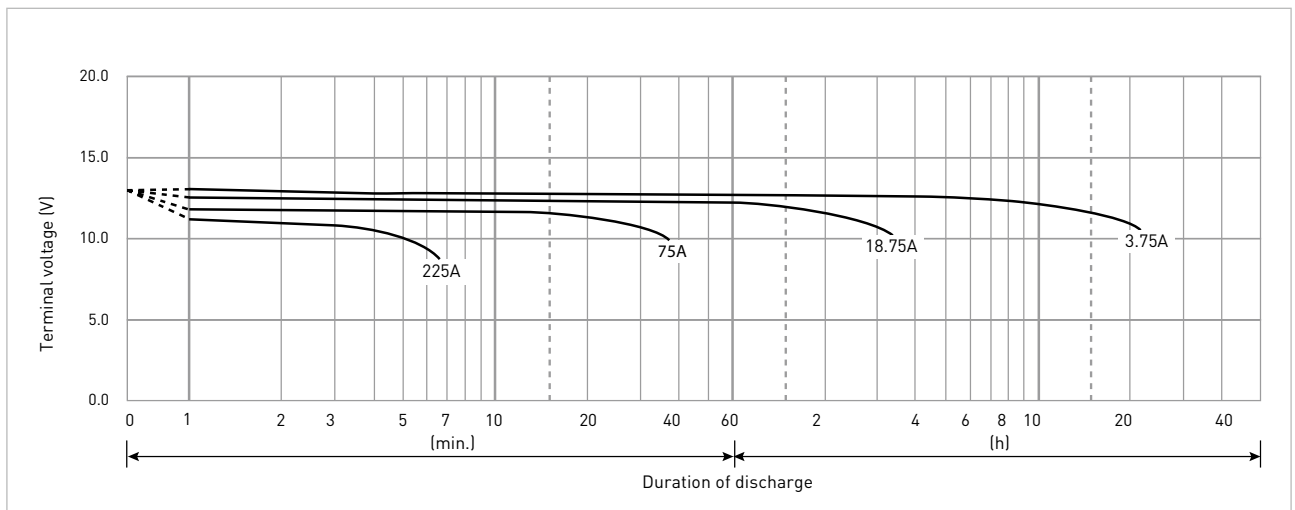
## CONSTANT-VOLTAGE CONSTANT-CURRENT CHARGE CHARACTERISTICS FOR TRICKLE USE



## DISCHARGE CAPACITY BY TEMPERATURE AND BY DISCHARGE CURRENT



## DISCHARGE CHARACTERISTICS



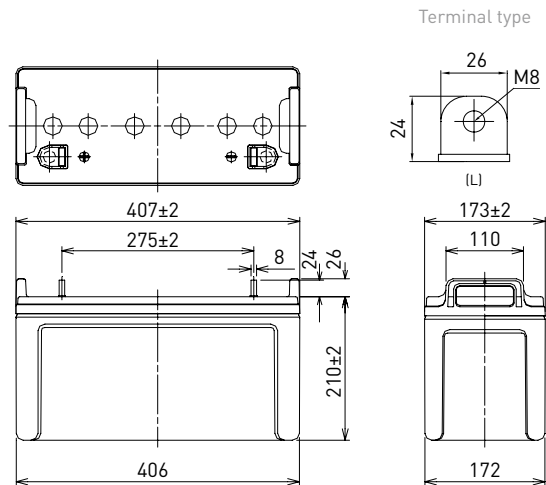
## LC-P12120P

FOR STANDBY POWER SUPPLIES.  
EXPECTED TRICKLE DESIGN LIFE: 10 - 12 YEARS AT 20°C  
ACCORDING TO EUROBAT.

### DIMENSIONS (MM)

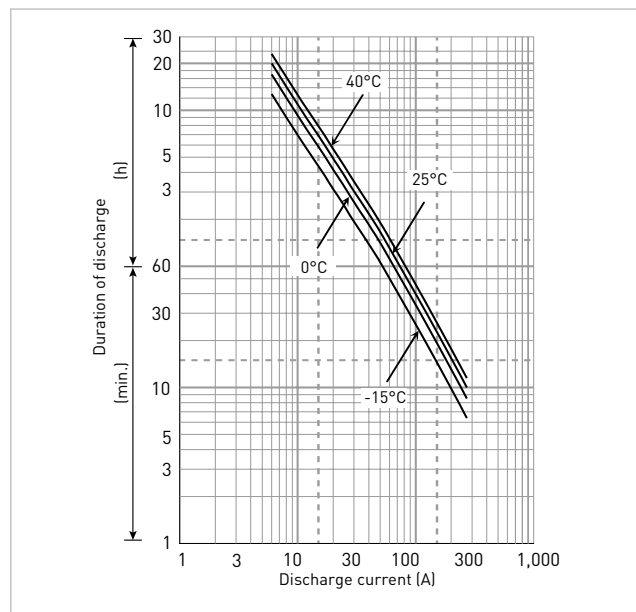


Contents indicated (including the recycle marking, etc.) are subject to change without notice. Battery case resin: flame-retardant (UL94 V-0)



Specifications		LC-P12120P
Nominal voltage (V)		12
Nominal capacity	20 hours rate (Ah)	120
Dimensions	Length (mm)	173
	Width (mm)	407
	Total height (mm)	236
Approx. mass (kg)		34.5
Terminal type		M8 bolt/nut
Capacity (25°C)	20 hours rate (Ah)	120
	10 hours rate (Ah)	110
	3 hours rate (Ah)	93
	1 hour rate (Ah)	85
Impedance (mΩ)	Fully charged battery (25°C)	4.5
Temperature dependency of capacity (%) - 20 hours rate	40°C	102
	25°C	100
	0°C	85
	-15°C	65
Remaining capacity (25°C)	After 3 months (%)	91
	After 6 months (%)	82
	After 12 months (%)	64

### DURATION OF DISCHARGE VS. DISCHARGE CURRENT



### WATT TABLE (25°C)

(Wattage/battery)

Cut-off	5min.	10min.	15min.	20min.	30min.	45min.	1h	1.5h	2h	3h	4h	5h	6h	10h	20h
9.6V	3,603	2,883	2,296	2,036	1,409	1,095	835	663	499	326	261	197	179	104	60.2
9.9V	3,537	2,849	2,285	2,024	1,370	1,062	820	662	486	322	255	191	177	103	60.1
10.2V	3,309	2,776	2,273	2,001	1,322	1,040	805	642	479	315	249	185	168	102	60.0
10.5V	3,020	2,572	2,148	1,907	1,316	1,025	779	629	470	310	246	184	166	101	60.0
10.8V	2,916	2,294	2,079	1,861	1,281	980	756	559	458	306	240	180	163	99.8	59.9

### AMPERE TABLE (25°C)

(Ampere/battery)

Cut-off	5min.	10min.	15min.	20min.	30min.	45min.	1h	1.5h	2h	3h	4h	5h	6h	10h	20h
9.6V	361	271	211	181	139	105	86.9	59.3	47.9	32.1	23.7	20.6	17.4	11.1	6.00
9.9V	357	267	210	180	138	102	86.6	58.1	47.5	31.5	23.4	20.4	17.3	11.1	6.00
10.2V	348	261	209	178	136	97.0	85.9	57.7	46.9	31.2	23.2	20.0	17.2	11.0	6.00
10.5V	322	241	198	170	134	92.0	85.4	56.9	46.3	31.0	23.0	19.9	17.1	11.0	6.00
10.8V	282	211	192	165	132	86.9	74.0	51.2	44.0	29.9	22.7	19.8	16.7	10.9	5.88

All mentioned values are average values

# LC-P12120P

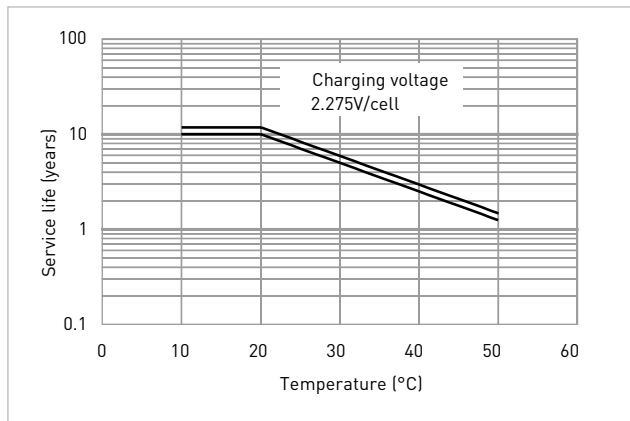
## CHARGING METHOD (25°C)

<b>Trickle use</b>	Control voltage: 13.6V - 13.8V Initial current: 18.0A or smaller
--------------------	---

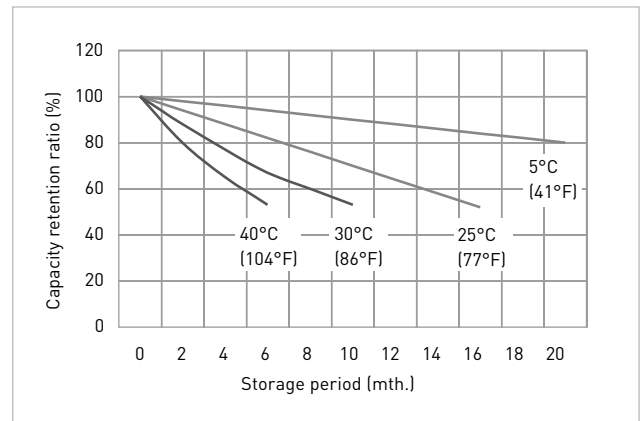
## CUT-OFF VOLTAGE

<b>Discharge current</b>	6.00A - 24.0A	24.0A - 60.0A	60.0A - 120A	120A - 240A	240A - 300A
<b>Cut-off voltage</b>	10.5V	10.2V	9.9V	9.3V	8.7V

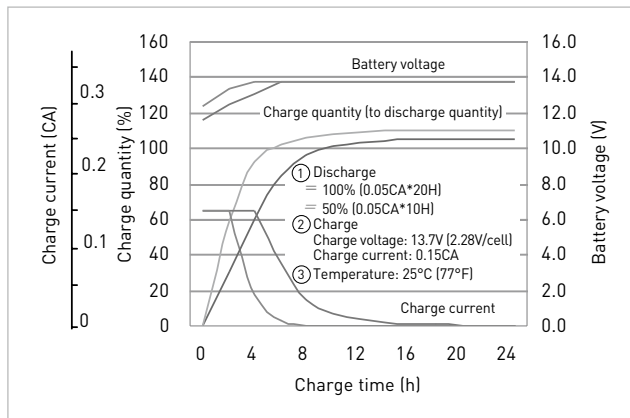
## INFLUENCE OF TEMPERATURE ON TRICKLE LIFE



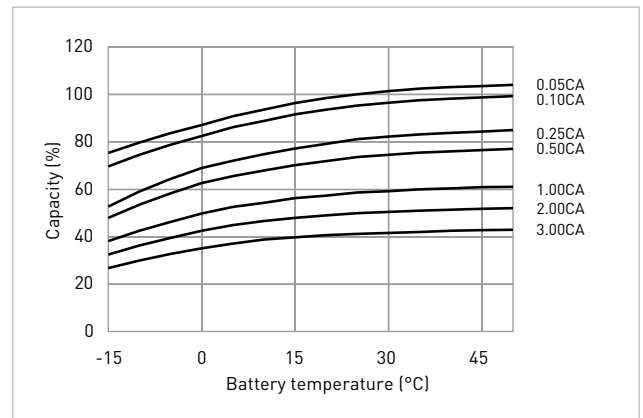
## RESIDUAL CAPACITY TEST RESULT



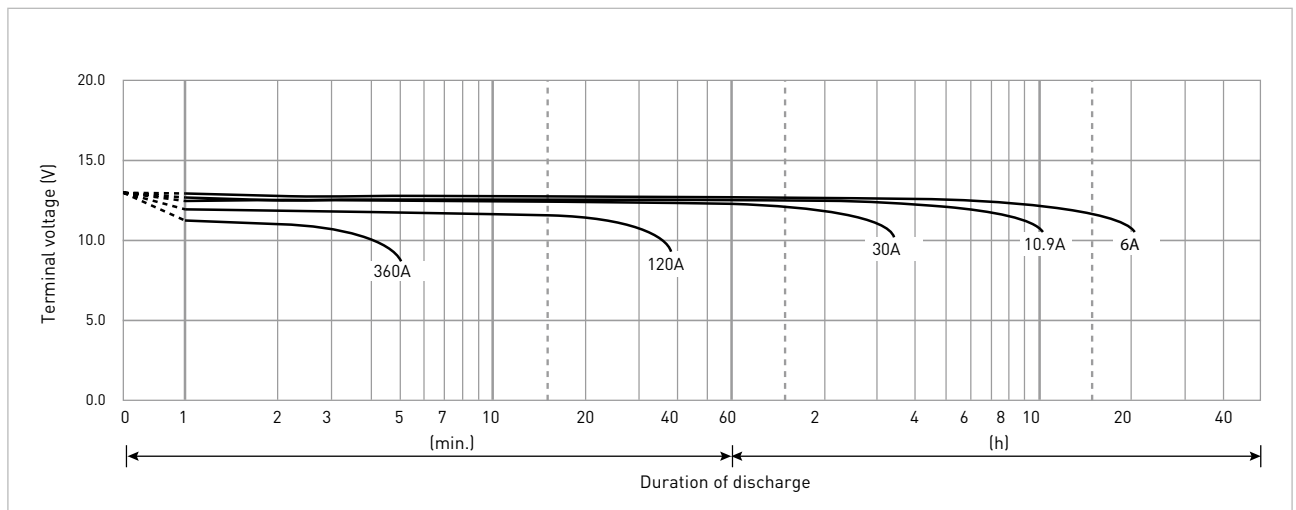
## CONSTANT-VOLTAGE CONSTANT-CURRENT CHARGE CHARACTERISTICS FOR TRICKLE USE



## DISCHARGE CAPACITY BY TEMPERATURE AND BY DISCHARGE CURRENT



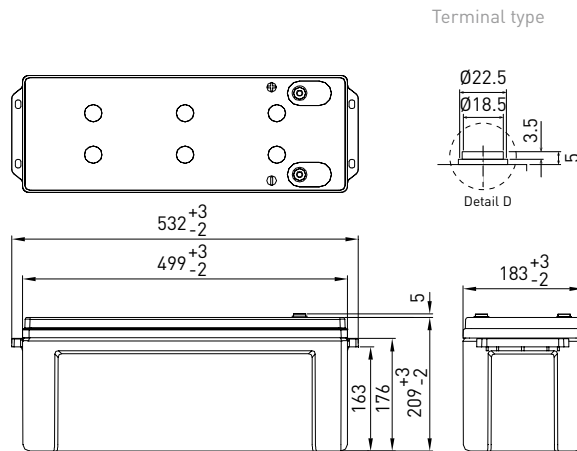
## DISCHARGE CHARACTERISTICS



# LC-P12150BP\*1

FOR STANDBY POWER SUPPLIES.  
EXPECTED TRICKLE DESIGN LIFE: 10 - 12 YEARS AT 20°C  
ACCORDING TO EUROBAT.

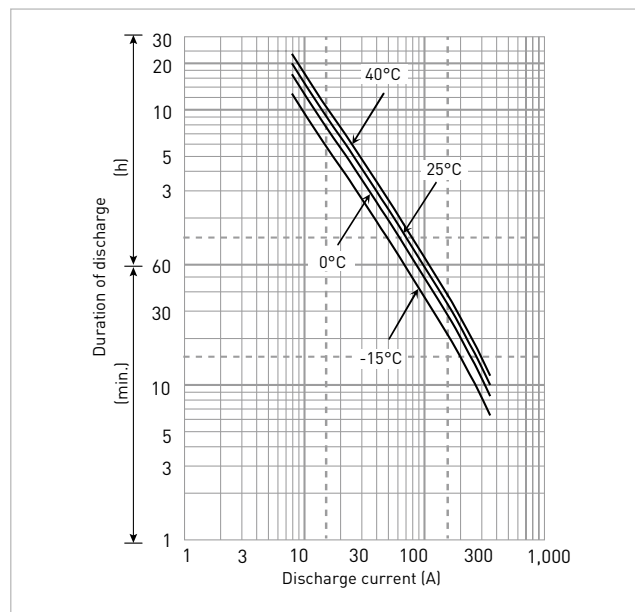
## DIMENSIONS (MM)



Contents indicated (including the recycle marking, etc.) are subject to change without notice. Battery case resin: flame-retardant (UL94 V-0)

Specifications		LC-P12150BP*1
Nominal voltage (V)		12
Nominal capacity 20 hours rate (Ah)		150
Dimensions	Length (mm)	183
	Width (mm)	532
	Total height (mm)	214
Approx. mass (kg)		43.0
Terminal type		M8x20 insert
Capacity (25°C)	20 hours rate (Ah)	150
	10 hours rate (Ah)	137
	3 hours rate (Ah)	119
	1 hour rate (Ah)	88
Impedance (mΩ) Fully charged battery (25°C)		3.5
Temperature dependency of capacity [%] - 20 hours rate	40°C	102
	25°C	100
	0°C	85
	-15°C	65
Remaining capacity (25°C)	After 3 months (%)	91
	After 6 months (%)	82
	After 12 months (%)	64

## DURATION OF DISCHARGE VS. DISCHARGE CURRENT



## WATT TABLE (25°C)

(Wattage/battery)

Cut-off	5min.	10min.	15min.	20min.	30min.	45min.	1h	1.5h	2h	3h	4h	5h	6h	10h	20h
9.6V	5,040	3,780	3,000	2,390	1,774	1,310	1,046	791	608	444	348	284	242	164	91.2
9.9V	4,925	3,689	2,923	2,334	1,727	1,276	1,013	763	596	437	342	281	240	163	91.2
10.2V	4,340	3,405	2,833	2,261	1,672	1,238	976	724	592	433	339	278	237	163	91.1
10.5V	4,020	3,216	2,751	2,197	1,641	1,208	947	695	585	428	334	274	235	161	90.3
10.8V	3,850	2,839	2,661	2,149	1,601	1,163	910	659	576	420	328	268	232	160	90.3

## AMPERE TABLE (25°C)

(Ampere/battery)

Cut-off	5min.	10min.	15min.	20min.	30min.	45min.	1h	1.5h	2h	3h	4h	5h	6h	10h	20h
9.6V	490	350	266	217	164	120	97.2	70.0	59.0	42.1	32.9	27.3	23.0	14.0	7.58
9.9V	479	342	259	212	159	117	94.1	67.5	58.0	41.3	32.3	26.7	22.6	13.9	7.58
10.2V	422	315	251	206	154	114	90.7	64.1	56.9	40.4	31.5	26.0	22.2	13.8	7.50
10.5V	381	298	244	200	151	111	88.0	61.5	55.8	39.8	31.0	25.7	22.0	13.7	7.50
10.8V	334	263	236	195	148	107	84.6	58.3	54.4	38.8	30.3	25.2	21.6	13.5	7.49

All mentioned values are average values

\*1 This battery is equipped with insert terminals.

# LC-P12150BP\*1

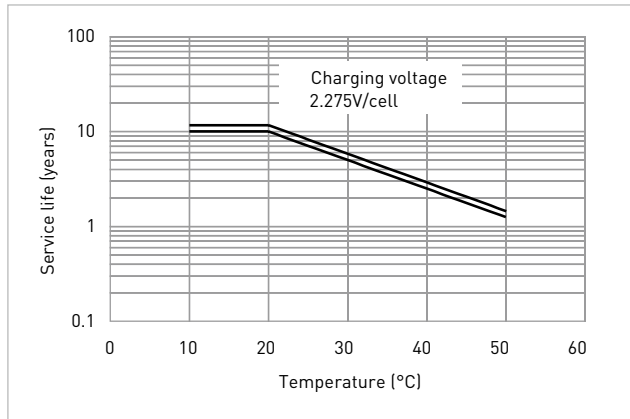
## CHARGING METHOD (25°C)

<b>Trickle use</b>	Control voltage: 13.6V - 13.8V
	Initial current: 22.5A or smaller

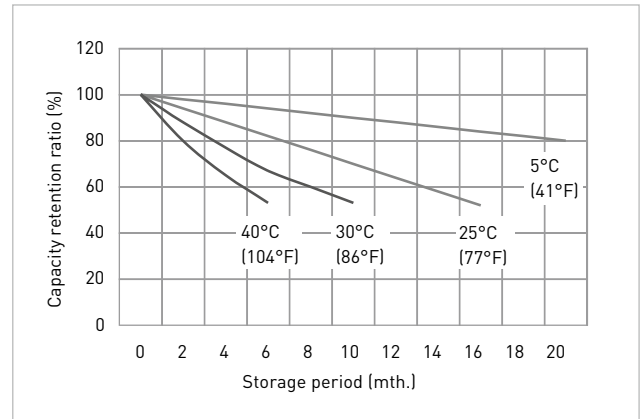
## CUT-OFF VOLTAGE

<b>Discharge current</b>	7.50A - 30.0A	30.0A - 75.0A	75.0A - 150A	150A - 300A	300A - 450A
<b>Cut-off voltage</b>	10.5V	10.2V	9.9V	9.3V	8.7V

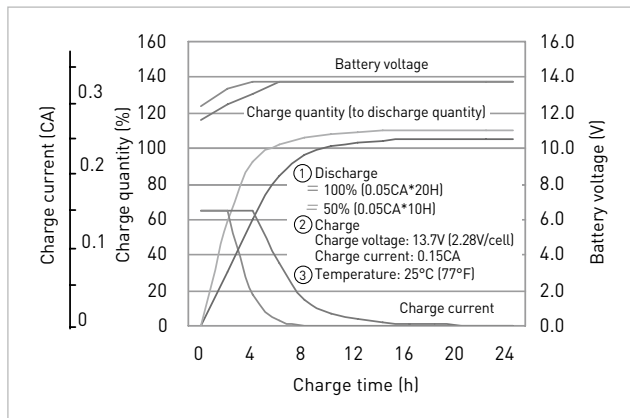
## INFLUENCE OF TEMPERATURE ON TRICKLE LIFE



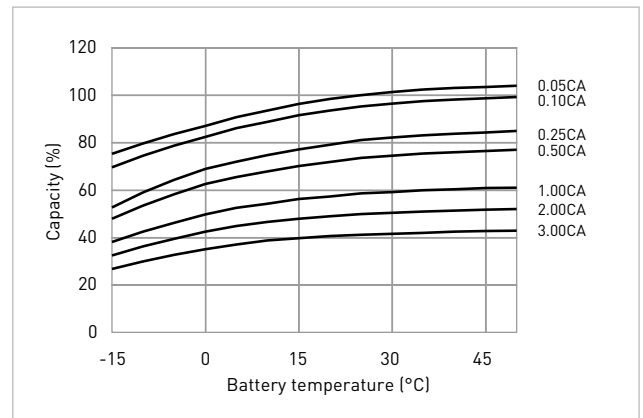
## RESIDUAL CAPACITY TEST RESULT



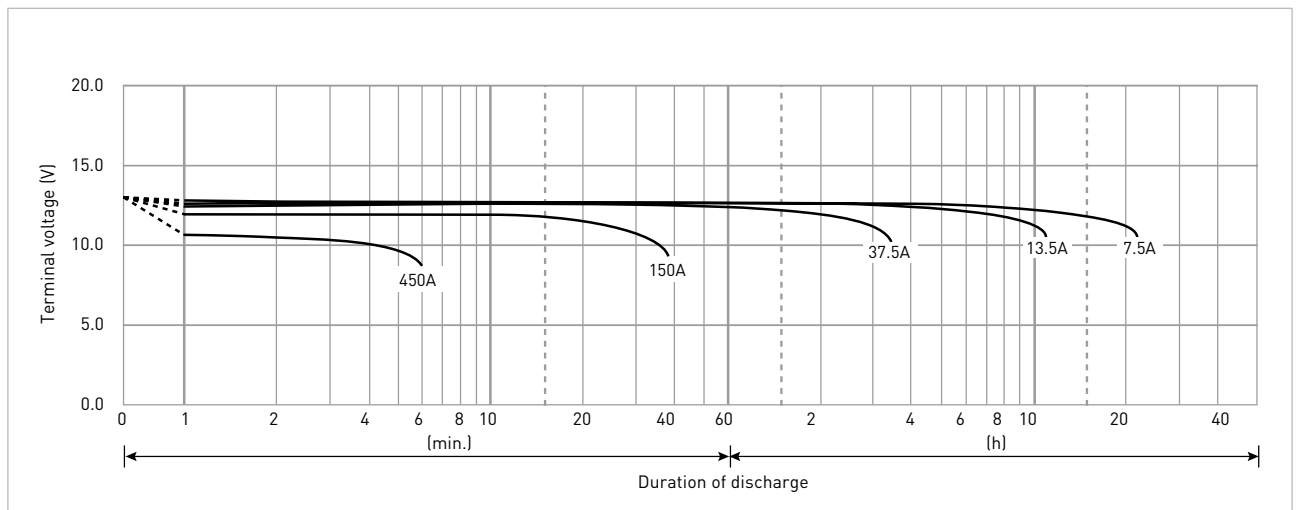
## CONSTANT-VOLTAGE CONSTANT-CURRENT CHARGE CHARACTERISTICS FOR TRICKLE USE



## DISCHARGE CAPACITY BY TEMPERATURE AND BY DISCHARGE CURRENT



## DISCHARGE CHARACTERISTICS



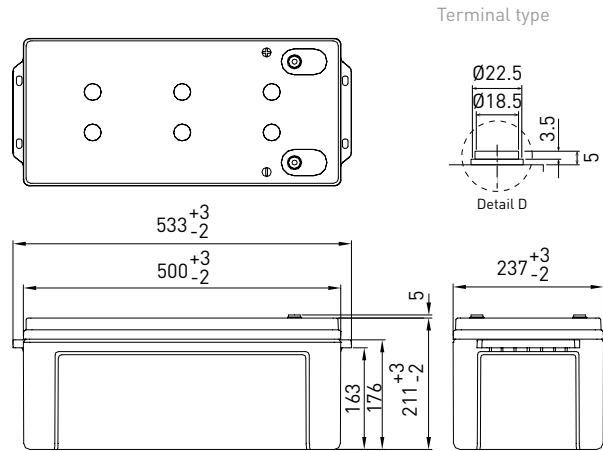
\*1 This battery is equipped with insert terminals.

The data in this document are for descriptive purposes only and are not intended to make or imply any guarantee or warranty. Regarding handling and safety please consult our VRLA technical handbook chapter 'Precautions for handling VRLA batteries'.

LC-P12200BP\*1

FOR STANDBY POWER SUPPLIES.  
EXPECTED TRICKLE DESIGN LIFE: 10 - 12 YEARS AT 20°C  
ACCORDING TO EUROBAT.

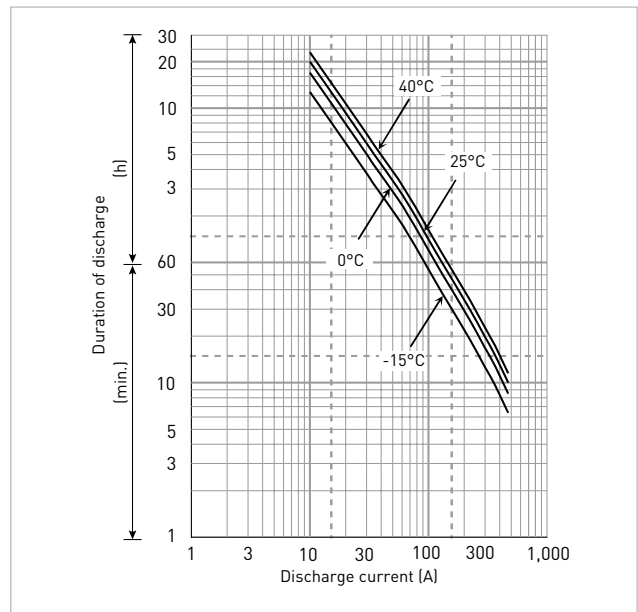
DIMENSIONS (MM)



Contents indicated (including the recycle marking, etc.) are subject to change without notice. Battery case resin: flame-retardant (UL94 V-0)

Specifications		LC-P12200BP*1
Nominal voltage (V)		12
Nominal capacity	20 hours rate (Ah)	200
Dimensions	Length (mm)	237
	Width (mm)	533
	Total height (mm)	216
Approx. mass (kg)		57.0
Terminal type		M8x20 insert
Capacity (25°C)	20 hours rate (Ah)	200
	10 hours rate (Ah)	187
	3 hours rate (Ah)	169
	1 hour rate (Ah)	118
Impedance (mΩ)	Fully charged battery (25°C)	2.5
Temperature dependency of capacity [%] - 20 hours rate	40°C	102
	25°C	100
	0°C	85
	-15°C	65
Remaining capacity (25°C)	After 3 months (%)	91
	After 6 months (%)	82
	After 12 months (%)	64

DURATION OF DISCHARGE VS. DISCHARGE CURRENT



WATT TABLE (25°C)

(Wattage/battery)

Cut-off	5min.	10min.	15min.	20min.	30min.	45min.	1h	1.5h	2h	3h	4h	5h	6h	10h	20h
9.6V	6,577	5,182	4,285	3,512	2,651	1,863	1,505	1,106	917	668	524	432	369	235	129
9.9V	6,427	5,052	4,264	3,491	2,577	1,807	1,478	1,105	893	660	512	420	363	234	128
10.2V	5,643	4,649	3,966	3,175	2,352	1,674	1,336	965	837	618	483	401	333	222	128
10.5V	5,092	4,390	3,851	3,085	2,308	1,634	1,296	925	821	608	475	396	331	221	128
10.8V	4,462	3,876	3,725	3,017	2,253	1,573	1,246	877	800	592	464	388	325	220	128

AMPERE TABLE (25°C)

(Ampere/battery)

Cut-off	5min.	10min.	15min.	20min.	30min.	45min.	1h	1.5h	2h	3h	4h	5h	6h	10h	20h
9.6V	655	471	366	297	222	163	130	95.7	86.0	59.6	45.6	37.0	30.2	19.0	10.1
9.9V	640	460	357	290	217	159	126	92.3	84.6	58.5	44.8	36.1	29.8	18.9	10.1
10.2V	564	425	346	281	210	154	121	87.7	83.0	57.3	43.7	35.3	29.2	18.8	10.0
10.5V	509	401	336	273	206	150	118	84.1	81.5	56.4	43.0	34.9	29.0	18.7	10.0
10.8V	446	354	325	267	201	145	113	79.7	79.4	54.9	42.0	34.1	28.4	18.5	9.99

All mentioned values are average values

\*1 This battery is equipped with insert terminals.

# LC-P12200BP\*1

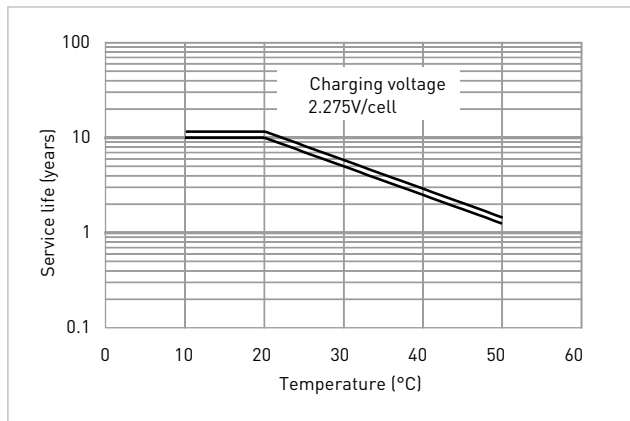
## CHARGING METHOD (25°C)

<b>Trickle use</b>	Control voltage: 13.6V - 13.8V
	Initial current: 30.0A or smaller

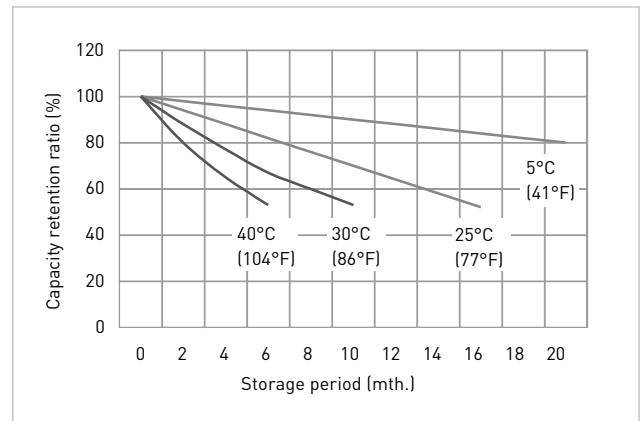
## CUT-OFF VOLTAGE

<b>Discharge current</b>	10.0A - 40.0A	40.0A - 100A	100A - 200A	200A - 400A	400A - 600A
<b>Cut-off voltage</b>	10.5V	10.2V	9.9V	9.3V	8.7V

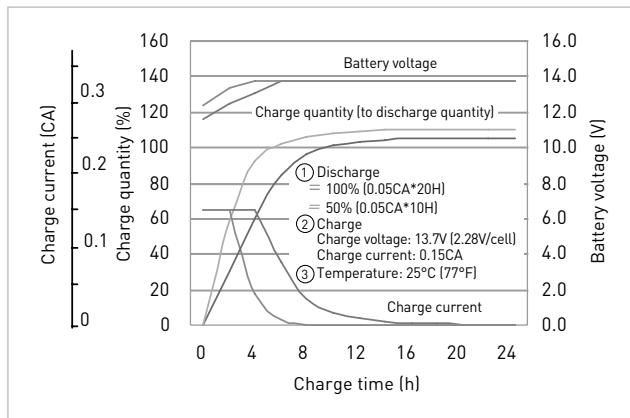
## INFLUENCE OF TEMPERATURE ON TRICKLE LIFE



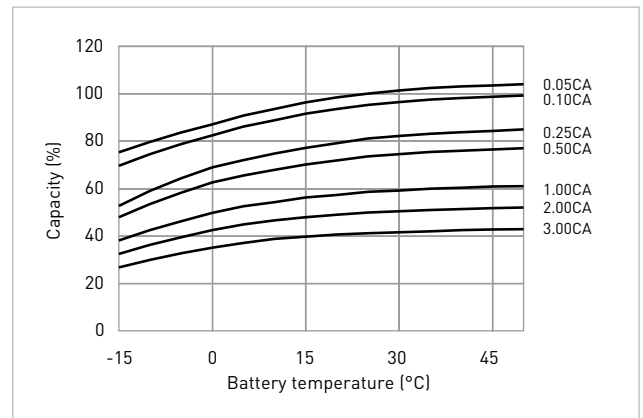
## RESIDUAL CAPACITY TEST RESULT



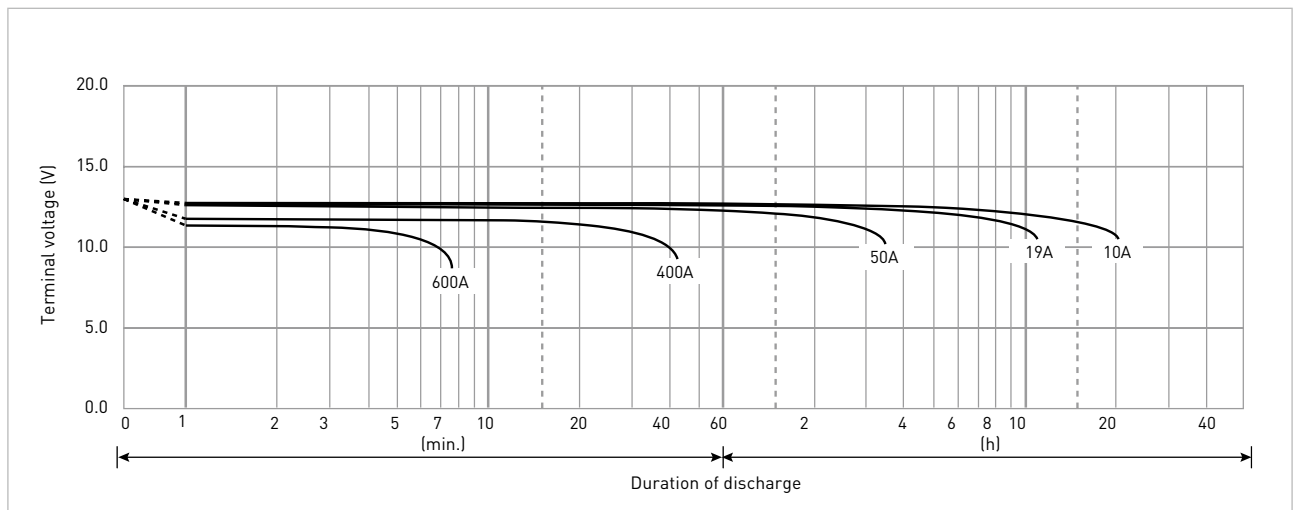
## CONSTANT-VOLTAGE CONSTANT-CURRENT CHARGE CHARACTERISTICS FOR TRICKLE USE



## DISCHARGE CAPACITY BY TEMPERATURE AND BY DISCHARGE CURRENT



## DISCHARGE CHARACTERISTICS



\*1 This battery is equipped with insert terminals.

## GLOSSARY OF MAIN BATTERY TERMS

---

### **ABS RESIN**

A plastic material largely used for the case and cover of batteries.

### **ACTIVE MATERIAL**

The substance which electrochemically reacts in the electrode of batteries. Lead acid batteries adopt Lead Dioxide for the positive electrode and spongy Lead for the negative electrode.

### **AMBIENT TEMPERATURE**

Average temperature in the vicinity of the battery.

### **AVAILABLE CAPACITY**

The capacity actually available from a cell/battery. The available capacity is the capacity of a battery when it discharges at a specified hours rate, and expressed in hours rate and Ah.

### **BOLT FASTENING TERMINAL**

A type of battery terminals, to which lead wires are connected with bolts.

### **BUILT-IN THERMOSTAT**

The built-in thermostat is a resettable switch built in a battery for temporarily Cut-off the battery circuit when the temperature of the battery exceeds a preset value or when the battery charges/discharges at a higher rate than predetermined.

### **CAPACITY**

The electric capability of a battery. It usually means ampere-hour capacity expressed in Ah or C (coulomb).

### **CELL**

The minimum battery unit which composes a storage battery. Nominal voltage of the cell of a lead acid battery is 2V.

### **CHARGE**

The operation of supplying a battery with a DC current from an external power source to have the electrode active materials conduct chemical reactions then to store electric energy as chemical energy in the battery.

### **CHARGE ACCEPTANCE TEST**

Test of batteries to check whether or not they are adequately recharged after discharge.

### **CHARGING EFFICIENCY**

General term for ampere-hour efficiency and watt-hour efficiency. In many cases it means the ampere-hour efficiency.

### **CHINA ROHS**

Environment Friendly Use period (EFUP) is the number of time before any of the RoHS substances are likely to leak out, causing possible harm to health and the environment.

### **CONSTANT CURRENT CHARGE**

A method of charging: to charge a battery with a constant current.

### **CONSTANT VOLTAGE CHARGE**

A method of charging: to charge a battery by applying a constant voltage to the terminals.

### **C-RATE**

A charge or discharge current rate expressed in A or mA. It is numerically the same as the hours rate capacity of a battery expressed in Ah of the rated capacity.

### **CUT-OFF VOLTAGE OF DISCHARGE**

The terminal voltage of a battery at which discharging should be discontinued. This voltage depends on discharge current, type of electrodes, and construction of battery.

### **CYCLE LIFE**

The number of charge/discharge/rest cycles a cell/battery can provide. Cycle life is usually expressed by the number of cycles available before duration of discharge decreases to half of the initial value.

### **DEPTH OF DISCHARGE**

A value to express the state of discharge of a battery. The depth of discharge is generally expressed by the ratio of discharge amount to rated capacity of the battery.

### **DISCHARGE**

To draw the electric energy stored in a cell/battery.

### **DISCHARGE RATE**

The term to express the magnitude of discharge current. When assuming discharge current and time to discharge cut-off voltage t hours, this discharge is called t hours rate (tHR) discharge, and the current is called t-hours rate discharge current. When time t is minutes instead of hours, tMR is used.

### **DUTY CYCLE TEST**

Test of batteries in ordinary use including charge, discharge and rest.

### **ELECTROLYTE**

The medium which serves to conduct ions in the electrochemical reactions in batteries. The lead acid battery uses diluted sulfuric acid as the electrolyte.



**ENERGY DENSITY**

Energy available per unit approx. mass or unit volume of a cell/battery. Energy density is expressed in Wh/kg or Wh/l.

**FLOAT CHARGE**

The system in which a constant voltage is continuously applied to a battery connected to a rectifier in parallel with a load to maintain the battery in charged state: on occurrence of power failure or load variation, the battery supplies power to the load without any short break.

**GAS RECOMBINATION**

Capability of a battery to recombine (or absorb) internally generated oxygen gas at the negative plate. The greater this capability is, the lower the charge current.

**HIGH RATE DISCHARGE**

A very rapid discharge of a battery. (In many cases it means discharging at approx. 1CA or higher rate.)

**IMPEDANCE**

The resistance within a battery: it is the total of individual resistances of the electrolyte and the positive and negative plates. Impedance is measured with the four-terminal sensing method (1,000Hz) and expressed in the composite value of resistance component and capacitance component.

**INTERNAL PRESSURE**

The pressure within a sealed battery. Internal pressure of a battery is increased by Oxygen gas which is generated from the positive plate at the end of charging.

**INTERNAL SHORT-CIRCUIT**

Touching of the positive and negative plates within a cell.

**LIFE**

The time period until a cell/battery loses its expected characteristics.

**LOW MAINTENANCE**

Low maintenance means that no watering nor equalizing charge is required in operating batteries.

**LOW-VOLTAGE CUT-OFF**

A circuit designed to discontinue discharge of a battery at a predetermined voltage level.

**MALE TAB**

The metallic pieces which are attached to a VRLA battery as the terminals.

**MEMORY EFFECT**

A phenomenon where a temporary drop of discharge voltage is observed during deep discharge of an Alkaline rechargeable battery which has been subjected to shallow charge/discharge cycles or trickle charging over long time.

**NEGATIVE PLATE**

The battery electrode into which a current from the external circuit flows during discharging. The negative plate has lower electric potential than the positive plate to the electrolyte. The negative plate is incorporated with connection parts such as the electrode pole.

**NOMINAL VOLTAGE**

A nominal value to indicate the voltage of a cell battery. Generally, nominal voltage value of a battery is somewhat lower than its electromotive force. Nominal voltage of the lead acid battery is 2.0V per unit cell.

**OPEN CIRCUIT VOLTAGE**

Measured voltage of a cell/battery which is electrically disconnected from the external circuit.

**OVERCHARGE**

Continued charging of a fully charged cell/battery. With batteries which require watering, overcharge causes electrolysis of water, resulting in rapid decrease of electrolyte. Generally, overcharge adversely influences battery life.

**OVERDISCHARGE**

Discharge of a battery to a voltage below a predetermined cut-off voltage.

**PARALLEL CHARGE**

Simultaneous charging of two or more batteries connected in parallel. In cyclic use of batteries, specifically, the parallel charge tends to cause an imbalance in charge state among the batteries, which may shorten their service life.

**POLYPROPYLENE RESIN**

A plastic material which is often used for the case and cover of batteries.

**POSITIVE PLATE**

The battery electrode from which a current flows to the external circuit during discharging. The positive plate has higher electric potential than the negative plate to the electrolyte. The positive plate is incorporated with connection parts such as the electrode lugs.

### **QUICK CHARGE (RAPID CHARGE)**

Charging in a short time with a large current.

### **RATED CAPACITY**

The stated capacity of a battery; namely, the ampere-hour amount which can be drawn from the battery in fully charged state at a specified temperature, at a specified discharge rate, and to a specified cut-off voltage. The symbol CN may be used to express the rated capacity of N-hours rate.

### **RECHARGEABLE BATTERY**

The rechargeable battery is a system comprising two different electrodes and an ion-conductive medium, which is capable of converting chemical energy to electric energy, and vice versa. It is also called a secondary battery.

### **REFRESH CHARGE (AUXILIARY CHARGE)**

Charging of a battery mainly to compensate for its self-discharge.

### **RESIDUAL CAPACITY**

Remaining capacity of a battery after partial discharge or after storage for long time.

### **RETAINER TYPE**

A method to control flowing electrolyte in a battery with the retainer mat, etc.

### **REVERSE CHARGE**

Charging of a battery with its polarity reversed.

### **SELF-DISCHARGE**

Reduction in capacity of a battery while no current is drawn by the external circuit. Self-discharge depends on temperature: amount of discharge approximately doubles by each (10°C) rise of ambient temperature.

### **SEPARATOR**

A porous or microporous liquid-absorbent material which is installed between the battery electrodes for preventing short-circuit, securing the separation of the electrodes and retaining electrolyte. The separator should be resistant to oxidation and chemicals; it should excel in electric insulation and liquid-retention; and it should not disturb diffusion of the electrolyte and ionic conduction.

### **STANDBY USE**

General term of constant standby battery systems. Batteries are kept charged by trickle/float method at all times in preparation for unforeseen power disruptions.

### **TEMPERATURE COMPENSATION**

Compensation of charge voltage for temperature variation of a cell/battery or in its vicinity. Qualitatively, charge voltage should be corrected to higher side for low temperatures and to lower side for high temperatures.

### **TERMINAL VOLTAGE AT DISCHARGE**

The voltage of a battery during discharging.

### **THERMAL RUNAWAY**

Such phenomena as an excessively high set-up voltage in constant-voltage charging of a battery and a very high battery temperature cause charge current to increase, which then raises the temperature further: this vicious cycle is called thermal runaway, which may, in the worst case, result in breakage of the battery due to heat.

### **TRICKLE CHARGE**

To charge a battery in the state of disconnection from the load to compensate for its self-discharge.

### **TRICKLE LIFE**

The service life of a battery in the trickle use. Usually, the trickle life is the time expressed in years before the dischargeable time of the battery decreases to a half of the initial value.

### **UL**

Abbreviation of Underwriters Laboratories Inc. in USA. The UL establishes various safety standards, and performs official recognition of materials, parts and products.

### **UPS (UNINTERRUPTIBLE POWER SUPPLY)**

Equipment or system which is automatically connected to the load to supply power if the main power fails.

### **VENT (ONE WAY VALVE)**

A valve on each cell which automatically releases gas from the battery when internal pressure of the battery exceeds a predetermined value: it prevents breakage of the battery due to excessive internal pressure caused by the gas generated by charging or other reasons. The valve also serves to prevent outside air from entering batteries.



# FIND THE RIGHT CONTACT



## YouTube Channel

Please find a comprehensive selection of Panasonic battery videos at our YouTube Channel.

<https://www.youtube.com/user/panasonicbatteries>



## E-mail and website for all European countries

[battery-solutions@eu.panasonic.com](mailto:battery-solutions@eu.panasonic.com)

<http://industry.panasonic.eu>

## Notice to Readers

It is the responsibility of each user to ensure that every battery application is adequately designed safe and compatible with all conditions encountered during use, and in conformance with existing standards and requirements. This literature contains information concerning cells and batteries manufactured by Panasonic Corporation. This information is descriptive only and is not intended to make or imply any representation, guarantee or warranty with respect to any cells and batteries. Cell and battery designs are subject to modification without notice.

# Panasonic®

Panasonic is a registered trademark of Panasonic Corporation. Printed in Germany 2021

© Panasonic Corporation

For more details please contact:

## United Kingdom/Ireland

Panasonic Industry Europe GmbH

Maxis 2, Western Road

Bracknell Berkshire

RG12 1RT, England

Phone: +44 1344 853260

## Italy

Panasonic Industry Italy (PIIT)

Viale dell' Innovazione 3

20126 Milano, Italy

Phone: +39 02 6788-1

## Spain/Portugal

Panasonic Industry Europe GmbH

Sucursal en España

Parque Empresarial @ Sant Cugat,

Via Augusta 15-25

Edificio B2 Planta 4 Oficina 17

08174 Sant Cugat del Valles

Barcelona, Spain

Phone: +34 93 5043010

## France

Panasonic Industry Europe GmbH

10, rue des petits ruisseaux

91370 Verrières-le-Buisson, France

Phone: +33 1 60135762

## Germany (all other European countries)

Panasonic Industry Europe GmbH

Winsbergring 15

22525 Hamburg, Germany

Phone: +49 40 8549-6373